



ILL 20/20 ENDURANCE

THE ILL'S NEXT
INSTRUMENT UPGRADE



NEUTRONS
FOR SCIENCE

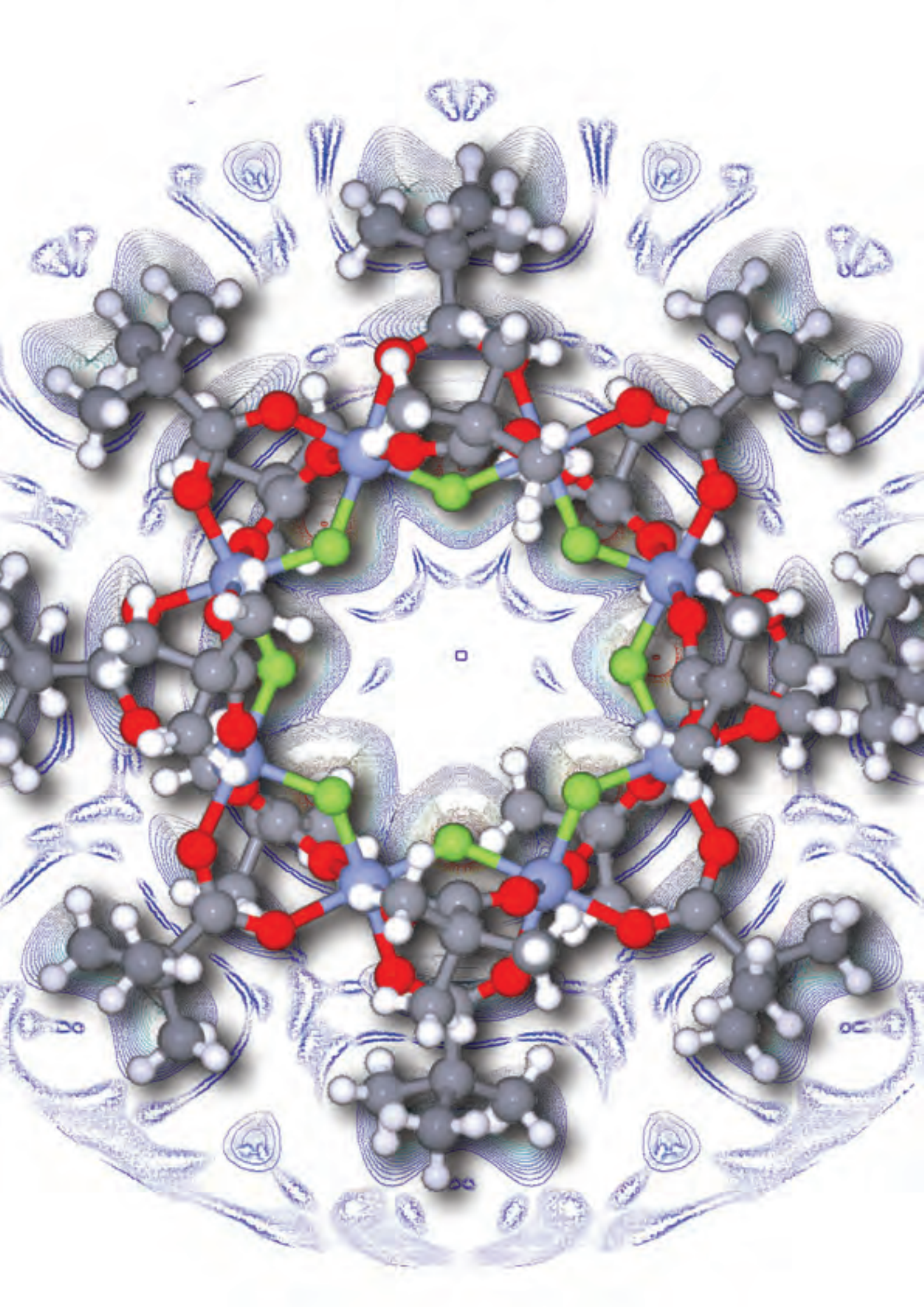

CONTENTS

4	ABOUT THE ILL	
5	FOREWORD	
6	THE ILL LEADING THE WORLD IN RESEARCH USING NEUTRONS	
12	FROM MILLENNIUM TO ENDURANCE The Millennium Programme has set a new benchmark in technological development to support research with neutrons	
14	THE INSTRUMENTS SUITE UPGRADE A technical programme overview	
18	FIPPS A new high-resolution spectrometer for studying exotic nuclei	Ulli Koester Email: koester@ill.eu
20	SuperSUN A world-beating source of ultra-cold neutrons for experiments in fundamental physics	Oliver Zimmer Email: zimmer@ill.eu
22	IN5* TIME-OF-FLIGHT SPECTROMETER Seeking out good vibrations	Jacques Ollivier Email: ollivier@ill.eu
24	RAMSES A new spectrometer for studying advanced materials in extreme environments	Marek Koza Email: koza@ill.eu
26	PANTHER A new thermal spectrometer for studying dynamics in complex solids	Stéphane Rols Email: rols@ill.eu
28	D7* DIFFUSE SCATTERING SPECTROMETER Exploring the quantum limits of disorder	Andrew Wildes Email: wildes@ill.eu
30	D10* TRIPLE-AXIS, FOUR-CIRCLE SPECTROMETER A flagship diffractometer for magnetism studies in various configurations and extreme conditions	Bachir Ouladdiaf Email: ouladdiaf@ill.eu
32	XtremeD A new diffractometer for high pressures and high magnetic fields	Juan Rodriguez Carvajal Email: jrc@ill.eu
34	RAINBOWS-FIGARO Refractive analysis of interfaces with neutron beams optimised for a white spectrum	Robert Cubitt Email: cubitt@ill.eu
36	ALADIN A world-class Laue diffractometer for structure exploration in complex materials	Marie-Hélène Lemée-Cailleur Email: lemee@ill.eu
38	OCTOPUS A multimodal diffractometer for advanced biological studies	Matthew Blakeley Email: blakeley@ill.eu
40	SuperSALSA Stress and imaging analysis for materials science and engineering	Thilo Pirling Email: pirling@ill.eu
42	exTAS A next-generation triple-axis spectrometer for millimetre-sized samples	Jiri Kulda Email: kulda@ill.eu
44	NESSE New standards for sample environment	Eddy Lelièvre-Berna Email: lelievre@ill.eu
46	BASTILLE A revolution for data treatment at the ILL	Mark Johnson Email: johnson@ill.eu

ABOUT THE ILL

The Institut Laue-Langevin (ILL) is an international research centre at **the leading edge of neutron science and technology**. It is located in a setting of outstanding beauty in the cosmopolitan city of Grenoble in south-east France.

The Institute operates the most intense neutron source in the world, feeding neutrons to a suite of 40 high-performance instruments that are constantly upgraded.

As a service institute, the ILL makes its facilities and expertise available to visiting scientists. Every year, about 2000 researchers from more than 30 countries visit the ILL. Over 800 experiments, which have been selected by a scientific review committee, are performed annually. Research focuses primarily on fundamental science in a variety of fields; these include condensed-matter physics, chemistry, biology, materials science, engineering, nuclear physics and particle physics.

Neutron-scattering experiments have made significant contributions to our understanding of the structure and behaviour of biological and soft condensed matter, to the design of new chemicals such as drugs and polymers, and to materials used in electronics and structural engineering. Neutron studies also offer unique insights into the nature of complex systems at the most fundamental level.

NEUTRONS FOR EUROPE

The ILL was founded in 1967 as a bi-national enterprise between France and Germany with the UK joining later in 1973. As well as these three Associate Members, 10 Scientific Members now participate in the ILL: Spain, Switzerland, Austria, Italy, the Czech Republic and more recently Sweden, Hungary, Belgium, Slovakia, Denmark and India.



NEUTRONS
FOR SCIENCE

FOREWORD

The ILL has led the world in neutron science for almost 40 years – a remarkable record that has been achieved by offering best-in-class instruments served by the brightest neutron source, and by attracting many of the most talented neutron scientists and technical staff to work with us. This, in turn, has meant that the instrument suite has had to evolve continuously by exploiting new technology – much of it developed in-house – to redefine the limits of what is measurable and offer new scientific opportunities.

The latest such development, stretching over more than a decade, is the Millennium upgrade programme, which has delivered an increase of more than a factor of 25 in average instrument brightness for less than one year's budget. This has not only enabled us to increase the number of experiments and thus users that we can support, but has also opened up completely new avenues of science. Recent achievements include the first *in-situ* measurement of the structure of a fluid as it passes through a microfluidic cell, thus providing direct insights into key manufacturing processes. Also observed for the first time is the relaxation of magnetisation in single crystals of a single-molecule magnet, which has provided unique information relevant to its potential for data storage and quantum computing.

However, there is still great potential to improve our facilities further by upgrading those instruments not yet boosted by the Millennium Programme. This brochure presents the plan for the new 'Endurance' initiative, which also embraces some of the complementary infrastructure for sample environment and software that enables world-leading instruments to deliver transformative science.

We are most grateful to our user community and external expert groups – our Scientific Council and Instrument Subcommittee – who have worked with us to identify which upgrades

to our instruments and infrastructure would have the greatest impact on key scientific and societal challenges. Together, we have explored how best to exploit some of the remarkable recent progress in neutron optics, detectors and guides to enable us to probe more complex materials over a wider range of length and energy scales, or more rapidly as they are transformed during synthesis or under real *in operando* conditions.

This programme will be rolled out into two phases over 8 years, organised in part around the neutron guides that serve the clusters of instruments, and also according to how far the current plans for each project in the programme has evolved.

Of course, the best instruments deserve the brightest source, and we aim to continue to provide this securely and reliably through our 'Supplementary Safety Actions' programme. We also plan to build on the success of our Partnership laboratories in Structural Biology and Soft Matter, by providing further essential, complementary facilities and support in the growth areas of neutron science. In parallel, we will explore how best to forge closer links with industry. All of this, together with Endurance, comprises the ILL '20/20 Vision' whose aim is to ensure that we continue to provide the best possible opportunities for exploiting science with neutrons throughout this decade and the next.



Andrew Harrison

ANDREW HARRISON
Director of the ILL



Helmut Schober

HELMUT SCHOBBER
Associate Director and Head
of Science Division



Charles Simon

CHARLES SIMON
Associate Director and Head of
Projects and Techniques Division

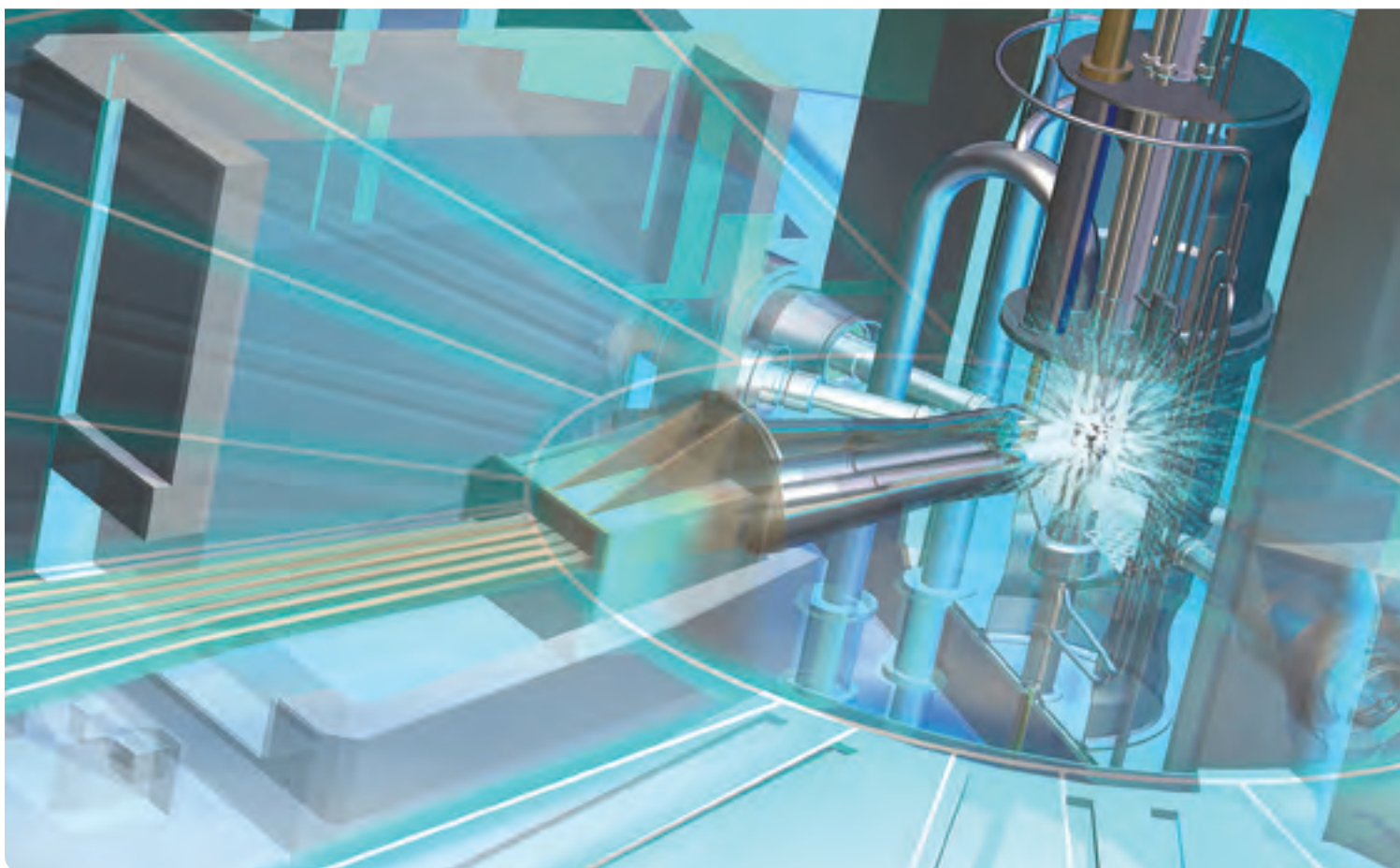

THE ILL LEADING THE WORLD IN RESEARCH USING NEUTRONS

NEUTRON SCATTERING AND RELATED ANALYTICAL TECHNIQUES USING NEUTRONS ARE BECOMING INCREASINGLY IMPORTANT TOOLS IN INTERNATIONAL SCIENCE AND TECHNOLOGY RESEARCH

When the first dedicated neutron sources were put into operation about 50 years ago, a wealth of fundamental scientific questions were awaiting experimental investigation. This was particularly true for solid-state physics and chemistry, which, following the quantum revolution, were developing at a fast pace, paving the road for our present understanding of matter at the microscopic level. With their specific properties, neutrons quickly proved to be an excellent probe with high predictive power in answering scientific questions that require the knowledge of atomic positions and motions, as well as for the study of magnetism. While this remains true to the present day, the nature of the investigations performed with neutrons has evolved considerably.



CONTINUING ADVANCES IN NEUTRON SCIENCE AND INSTRUMENTATION

Neutron science has successfully adapted to the ever-changing scientific and technological research landscapes. This has been possible only because of progress in instrumentation, which has constantly improved signal quality and reduced the constraints on sample size and composition. In most cases, it is no longer true that the choice of the materials investigated is dictated by the requirements of the neutron experiment – as was often the situation in the early days. This freedom of choice is a prerequisite for opening up neutron scattering to a wider user community.

As the signal quality has continued to improve, the range of experimental conditions offered to users has broadened. Kinetic experiments with greatly improved time resolution have become possible. The accessible ranges and precision in temperature, pressure, and magnetic and electric fields are increasing all the time, making it possible to conduct experiments under extreme conditions with a high scientific and technological impact – for example in the geosciences. Sophisticated offline and online equipment for sample preparation and characterisation has become available for soft-matter and life-science investigations. And last, but not least, neutron science has been able to take full advantage of the IT revolution for data reduction and analysis. All of these developments taken together now enable us to look at much more complex materials, perhaps during processing or synthesis and under real *in operando* conditions.

MEETING NEW CHALLENGES

The ILL has always been a frontrunner in the field of neutron science, pioneering many of the above developments. This is particularly true of the recently completed Millennium Programme, which – in a little more than a decade – has enabled the Institute to modernise a large part of its instrument suite. As explained in more detail on p12, the Millennium Programme has boosted signal quality by a factor of 25 for an investment of less than 10 per cent of the operating budget. However, as the past 50 years have shown, there is no room for complacency. It is in the nature of science to evolve, and the current evolution is strongly driven by the need to tackle the major societal challenges of our times. The demands placed on analytical probes such as neutron scattering will therefore continue to grow. The ILL sees its role as leading this development by offering its current users a world-class scientific infrastructure, while at the same time

developing innovative neutron methodologies and technologies to prepare the way for the community of the future. In order to achieve this goal, it is essential that the Institute continues to modify and improve its installations, taking full advantage of its decades of accumulated experience and expert knowledge of its source and infrastructures. This is the philosophy underlying the ILL's **Endurance Programme**.

THE SCIENCE WE CAN DO

The theoretical and experimental progress in solid-state physics and chemistry has been such that we now have a profound understanding of many phenomena at the

The construction of the ILL around 50 years ago, marked the start of a new era in scientific research at the atomic scale. Today, the flagship neutron facility continues to push back the frontiers of discovery



atomic and molecular levels. Thanks to this excellent foundation, it is becoming increasingly realistic to turn our attention to technological materials in order to tailor their properties starting at the atomic scale. Our focus has thus shifted to not only exploring more exotic physical phenomena but also to

"...NEUTRON SCIENCE HAS SUCCESSFULLY ADAPTED TO THE EVER-CHANGING SCIENTIFIC LANDSCAPE"

designing functional materials required to support society's urgent needs: more advanced communications and computer processing, efficient manufacturing and engineering processes, sustainable energy production, and solutions to key environmental problems. Building on the huge advances in molecular biology and genetics, we also are now

developing the capabilities to study complex biomolecular systems leading to new therapies and biomaterials that improve the length and quality of life. And in terms of basic knowledge, highly innovative experiments with neutrons continue to provide powerful insights into the nature of matter and interactions at both the nuclear and fundamental levels.

The science performed at the ILL now covers this vast array of topics to which the upgrades constituting the Endurance Programme will make major contributions:

■ Studies on advanced magnetic and electronic materials

The bulk of investigations at the ILL involve using neutron scattering to probe the structure and dynamics of condensed matter on the atomic scale. The most important single field of investigation in this respect is magnetism. Magnetism plays a fundamental role in many physical phenomena, with a high-impact potential in areas such as energy, transport and information technology. The continuing strong interest in studying the magnetic structure and dynamics of potentially useful materials – for example, the magnetic excitations that most probably explains high-temperature superconductivity – is clear evidence of its relevance. Another field of study of growing technological importance is the study of multiferroic materials, with their wealth of functionalities in electronic devices.

“...THE MODERNISATION OF THE SAMPLE ENVIRONMENT WILL GUARANTEE THAT EVERYTHING AN INSTRUMENT CAN POTENTIALLY OFFER CAN ACTUALLY BE EXPLOITED”

Due to their quantum nature, magnetic systems have an intrinsic complexity that continues to surprise us with hitherto unexpected physical behaviour that one day may well find technological use in quantum computing. Understanding these emerging phenomena is a challenge both for experiment and theory. Investigations at the ILL are at the very heart of this endeavour and continue to contribute some of the most important pieces of experimental evidence. This success builds on optimised instrumentation, combined with a suitable sample environment, in particular very low temperatures and high magnetic fields. Within Endurance, both of these pillars will be reinforced considerably. The projects, **XtremeD** and **D10***, will develop new capabilities for investigating magnetic structures including thin

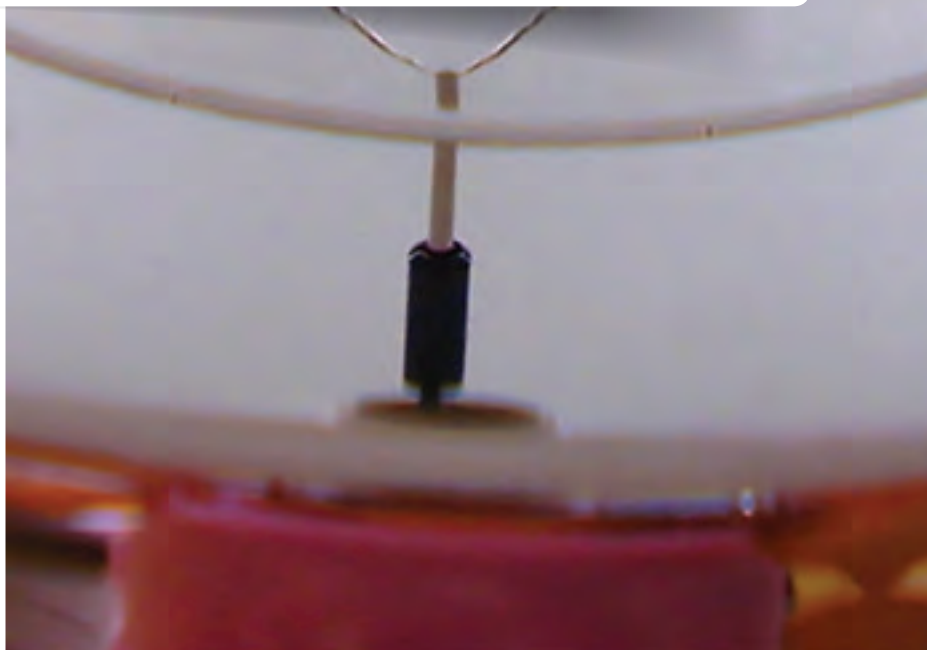
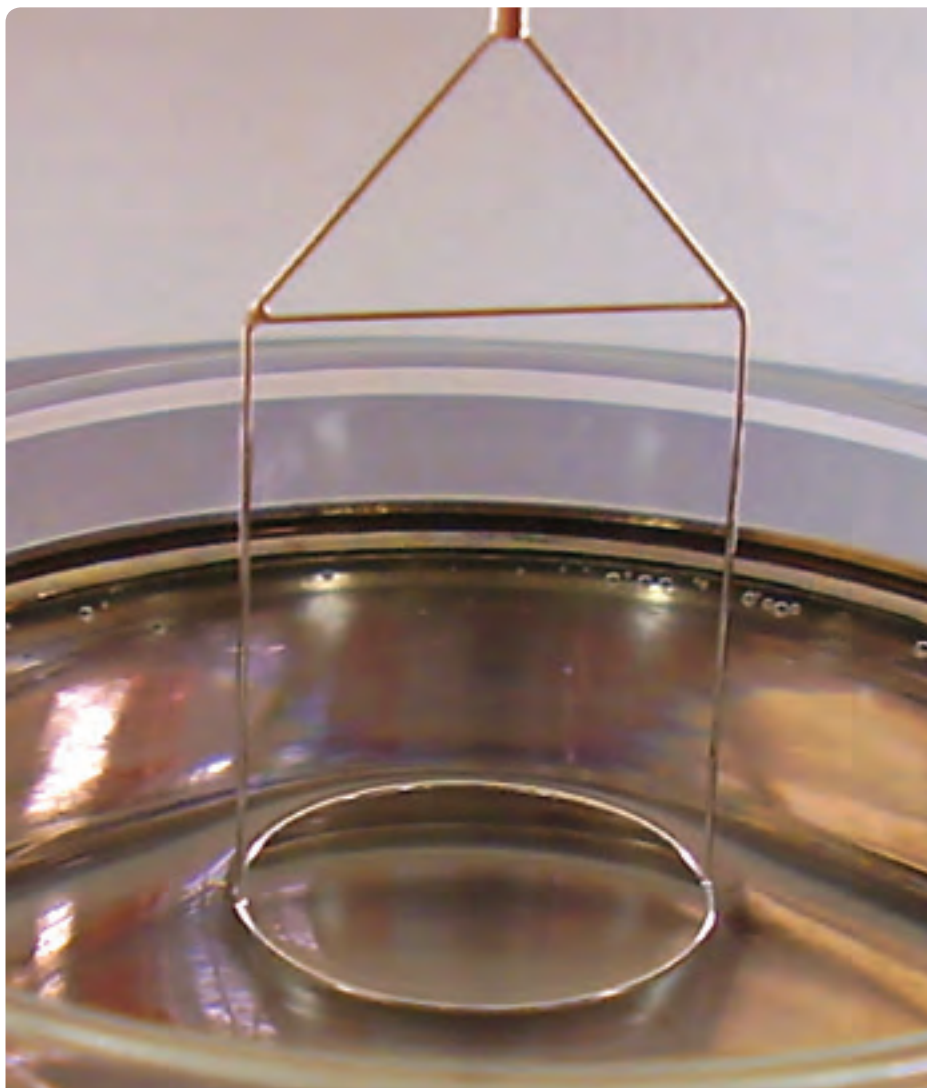

films and materials used in devices. Inelastic experiments on magnetic excitations will take advantage of the projects, **PANTHER**, **IN5⁺** and **D7**. Not only will these instruments provide outstanding performance in terms of flux and resolution, but also polarisation analysis over the full spectral range, building on the long-standing experience of the ILL in this domain. In addition, a further demonstration project, **extAS**, will develop a concept to realise inelastic studies of strategically important magnetic materials for which only very small crystals indeed can be prepared.

■ Exploring new materials and green energy applications

When it comes to the investigation of atomic structure and atomic motion, neutrons face stiff competition from X-rays and optical spectroscopy. The utility of neutrons as an important probe in the vast field of chemical crystallography and spectroscopy has, however, not diminished over the years. Quite to the contrary, it has recently gained new importance with the interest in functional solids containing combinations of atoms for which neutrons offer ideal contrast. This is the case, for example, in the majority of energy applications where light atoms such as hydrogen and lithium play a fundamental role, or where the exact positions and motions of oxygen atoms have to be determined in the presence of metals. This is the case, for example, in solid-oxide fuel cells. The extension of the range of temperatures and pressures accessible to users has been instrumental in maintaining the attractiveness of ILL instrumentation in these important areas. Within Endurance, the instrument projects, **XtremeD** and **ALADIN**, will perpetuate the ILL's success in the area of chemical crystallography by further extending the accessible parameter space far beyond current possibilities. In addition to energy research, geo- and extraterrestrial sciences will benefit particularly strongly from these upgrades.

When it comes to atomic dynamics, instrumentation at the ILL covers a range in frequency and momentum that is unique in the world and not accessible to any other experimental probe. The instrument projects, **RAMSES**, **IN5⁺** and **PANTHER**, aim to consolidate and develop these capacities further.

The unique imaging that can be carried out with neutron diffraction will be exploited further with **SuperSALSA** to analyse the changes in chemical composition as well as microscopic structure in large-scale manufactured and geological objects, and in real time.



■ Analysing soft complex materials

Our natural environment owes its diversity to the clement conditions that prevail on Earth. These allow the formation of stable dynamic (mostly supramolecular) systems such as colloids, micelles, surfactants, polymers and bio-systems, and their complexes and mixtures, and this on various length and time-scales. Neutron scattering is ideally suited to access both the structure and the dynamics of these systems, which are not only at the very origin of life but have also assumed prime technical importance for the chemical and pharmaceutical industries, as well as for cosmetics and food sciences. The importance of these systems, which are collectively known as soft matter, for the environment is self-evident.

However, there are also a rising number of emerging applications in the field of energy, for example, in the development of cheap solar cells. The growing interest shown in soft matter by industrial and academic research is reflected in the ever-increasing number of neutron experiments being conducted. With its unparalleled concentration of small-angle instruments, reflectometers and neutron spectrometers of a quality that cannot be found anywhere else in the world, the ILL is ideally positioned for such investigations. To strengthen its instrument suite still further, the Endurance project, **RAINBOWS-FIGARO**, will enhance capabilities for studying surfaces and interfaces, in particular to allow the study of kinetic processes on hitherto inaccessible timescales. As far as dynamics on a molecular timescale are concerned, the instruments, **RAMSES** and **IN5⁺**, with their drastically improved signal quality, will open up routes for studying more complex and more diluted systems.

■ Ground-breaking research in the life sciences

The most complex and exciting chemical processes are to be found in living organisms. In the life sciences, researchers seek to associate biological functions with these processes, focusing primarily on issues in medicine, health, and biotechnology. Key information at the molecular level can be obtained from neutron structural studies of crystals, solutions and partially ordered systems. Neutron crystallographic studies can yield unique atomic-resolution images (including hydrogen atoms) of complex macromolecules and molecular assemblies needed to explore the processes of life. Interactions of large biomolecules with pathogens or therapeutic drugs can be mapped, particularly in relation to protonation states and hydrogen bonding, in a way not obtained by any other means.

Future work will go beyond the purely static picture by providing snapshots of a structure or system as it changes over time. By working with samples in aqueous solution, small-angle scattering investigations can provide access to the secondary structures of proteins – molecules that readily do not crystallise. The ability to exploit D_2O/H_2O contrast variation, in conjunction with specific deuteration, provides a unique tool. The ILL, with its excellent small-angle suite and flagship single-crystal diffractometers, LADI-III and D19, pioneered this field of research and the interest of the community continues to grow, as demonstrated by beam-time requests in this area. Much of this success is undoubtedly due to the availability of the ILL Deuteration Laboratory (D-Lab) within the Life Sciences group and its ability to provide the community with custom-deuterated proteins. Within Endurance, the project, **OCTOPUS**, has the ambition of becoming the new reference in biological neutron crystallography. Most biological processes are activated only if accompanied by the appropriate atomic or molecular motions, and high-resolution neutron spectroscopy offers exactly the right time-window for observing these movements. The ILL suite of spectrometers is today second-to-none in this area, and biological work in dynamics again makes crucial use of macromolecular deuteration

■ A tool for nuclear physics/astrophysics

Using the high flux of neutrons available at the ILL, it is possible to create very neutron-rich nuclei by neutron capture. The study of the decay of these exotic species provides key information about the structure and stability of atomic nuclei, and is essential for understanding the nucleosynthesis of the elements in stars. Furthermore, it is extremely relevant to

advanced nuclear technology. For nuclear energy to become a sustainable part of the energy portfolio, a detailed knowledge of the relevant nuclear processes is needed to address important technological problems in production and waste treatment. A recent measuring campaign known as EXILL attracted enormous interest from the nuclear physics community. It allowed more than 100 neutron-rich fission nuclei to be investigated. Within Endurance, the project, **FIPPS**, will extend the experiments to more exotic nuclei by combining a mass spectrometer with gamma-ray spectroscopy. This project is enthusiastically supported by the community and will help to maintain the ILL's role as an important contributor to nuclear physics, alongside particle accelerator sources such as GANIL in France and FAIR in Germany.

“...NEUTRON SCATTERING HELPS US TO UNDERSTAND AND DEVELOP BETTER MATERIALS TO ADDRESS THE KEY CHALLENGES TO SOCIETY, TODAY AND IN THE FUTURE”

■ Research into fundamental physics

While the majority of investigations use the neutron as a scattering probe, the neutron in itself is also an exciting object of investigation. Because of the absence of electromagnetic interactions, it is the subatomic particle best suited for probing the gravitational force. Studies of its lifetime, decay and dipole moment explore the most fundamental theories in physics. The ILL's outstanding success in this field is closely associated with its ability to produce very intense cold and ultra-cold neutron (UCN) beams. Major efforts are currently being made worldwide to increase by several orders of magnitude the UCN density available in storage volumes. Building on its solid foundation of experience with helium UCN-converters, the project, **SuperSUN**, hopes to be a strong competitor. This staged project, whose feasibility phase is part of Phase I of the Endurance Programme, holds the firm promise of maintaining the ILL as a major player in the UCN field.





A POWERFUL SUPPORT STRUCTURE

From all that has been said so far, it is obvious that the instruments are only one element of success. Without the proper environment, it is impossible to do modern science. The ILL realised this fact early on and took appropriate action by investing in auxiliary infrastructure. The new Science Building built with the help of French regional funds (CPER), which will host partnerships including industry in various technological and scientific areas, attests to this fact.

Endurance aims to accelerate the process of improvement. In particular, investment in sample environment has been outpaced by instrument development, but with its ambitious renewal programme, **NESSE**, Endurance will redress this situation, bringing significant dividends to all scientific fields from materials to soft-matter research and biology. Combined with the Partnerships for Structural Biology and Soft Condensed Matter, which already provide outstanding possibilities for sample preparation, the modernisation of the sample environment will guarantee that everything an instrument can potentially offer can actually be exploited. **NESSE** is therefore a top-priority component within Endurance.

It is certainly fair to say that in the recent years no other single development has had a more pronounced impact on science than information technology. Data reduction and data analysis have reached an extremely high degree of sophistication. This was also necessary in order to cope with the flood of information provided by modern neutron instrumentation. The breadth of user requirements in terms of data analysis poses a real challenge to all neutron facilities. This problem is addressed coherently by the

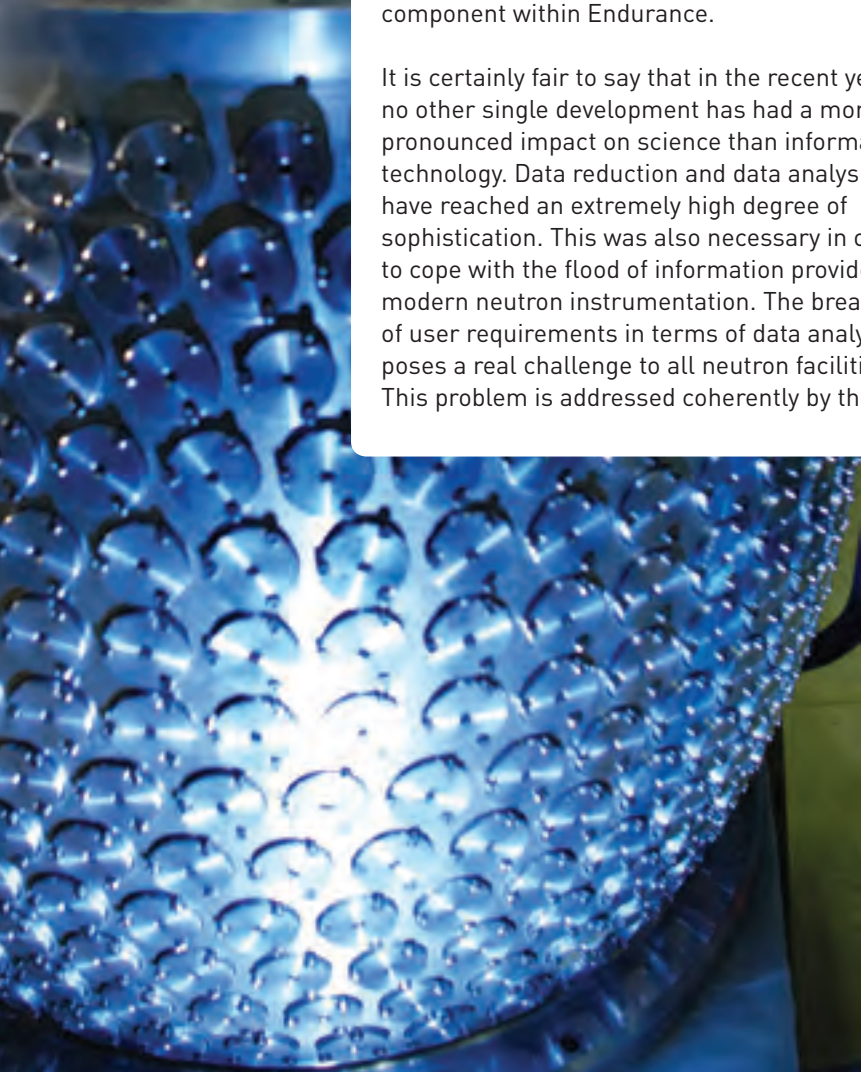

Endurance project, **BASTILLE**, which, like **NESSE**, is of the highest importance. Without a significant effort in this area, the scientific production pipeline runs the risk of becoming clogged up when it comes to transforming high-quality data into publishable scientific results. This is particularly true for non-professional and industrial users.

OPTIMISING THE UPGRADE PROGRAMME

The projects presented in this brochure are the result of a Draconian selection process that started in 2010 with the Vision2020 meeting, where ILL scientists' ideas for modernisation were placed face-to-face with the expectations of the user community. Driven by the support of the community, the project teams set out to elaborate their proposals, making them suitable for evaluation. The evaluation phase of what was to become the Endurance Programme started in 2012 under the close scrutiny of the projects by the Instrument Subcommittee.

At this point, it became apparent that the success of the programme depended to a large extent on the ILL's ability to provide ideal beam positions. Building on the experience gained during the Millennium Programme, the ILL put forward a further ambitious optimisation of its guide system, making it possible to incorporate more upgrades of flagship ILL instruments into the Endurance Programme. On the recommendation of the Instrument Subcommittee, the Scientific Council asked the ILL Management to opt for a phased approach for Endurance, as this had proven extremely successful for the Millennium Programme. Phase I would comprise projects with a level of maturity warranting immediate implementation. Phase II would be composed of projects requiring further elaboration. The Instrument Subcommittee would look into them again at a later stage. This approach offers the additional advantage of allowing new ideas to be incorporated into Phase II in the years to come.

In this brochure you will find a short description of all the projects that make up Endurance (both Phases I and II). The scientific examples have been selected so as to best illustrate the transformative experimental capabilities that will be created by Endurance. We hope they will convince you that, building on the achievements of the Millennium Programme, Endurance will guarantee that the ILL remains the world's premier location for performing exciting neutron science – that will help to further the successful scientific ideas and applications of the future.

FROM MILLENNIUM TO ENDURANCE

THE MILLENNIUM PROGRAMME HAS SET A NEW BENCHMARK IN TECHNOLOGICAL DEVELOPMENT TO SUPPORT RESEARCH WITH NEUTRONS

AT THE BEGINNING OF THIS CENTURY, A CHALLENGING ROADMAP FOR THE UPGRADE AND CONSTRUCTION OF INSTRUMENTS AT THE ILL WAS DRAWN UP. IT HAD BECOME APPARENT THAT A RENOVATION PROGRAMME WAS NEEDED TO STRENGTHEN THE ILL'S WORLD-LEADING POSITION IN NEUTRON SCIENCE BY TAKING ADVANTAGE OF EXCITING NEW TECHNOLOGICAL DEVELOPMENTS IN THE AREAS OF NEUTRON DETECTORS, NEUTRON OPTICS AND TRANSPORT, AND IN THE PROVISION OF POLARISED NEUTRON BEAMS, THAT WOULD ENABLE A NEW SET OF SCIENTIFIC GOALS TO BECOME ACHIEVABLE.

Thus in 2000, the Millennium Programme was launched to improve selected instruments during the period 2001 to 2008. To meet the continuously evolving scientific needs of users, the ILL has now prolonged this programme of upgrades to a second phase, going from 2008 to 2014. To achieve the construction of world-leading instruments, the programme was also broadened to include beamlines and instrumentation involving the redesign of neutron guides, instrument-control software and sample-environment equipment.

Thanks to the financial support of the Associate Members, and to the contributions of our enthusiastic staff, the Millennium Programme has been able to deliver 10 completely new instruments and 10 upgraded ones, exceeding the original goals and expectations. The budgetary contribution assured by the Associate Members enabled parallel financing to be obtained to realise further projects not included in the Millennium Programme. From the financial and technical point of view, the synergy created has been vitally important in generating new opportunities.

Only recently, in the second part of the Programme (Phase M1), the large-scale instrument suite has been completed, with the construction of D33 – a time-of-flight (TOF) SANS machine optimised for material science – so leaving D11 and D22, modernised in the previous phase, for the study of biology and soft condensed matter.

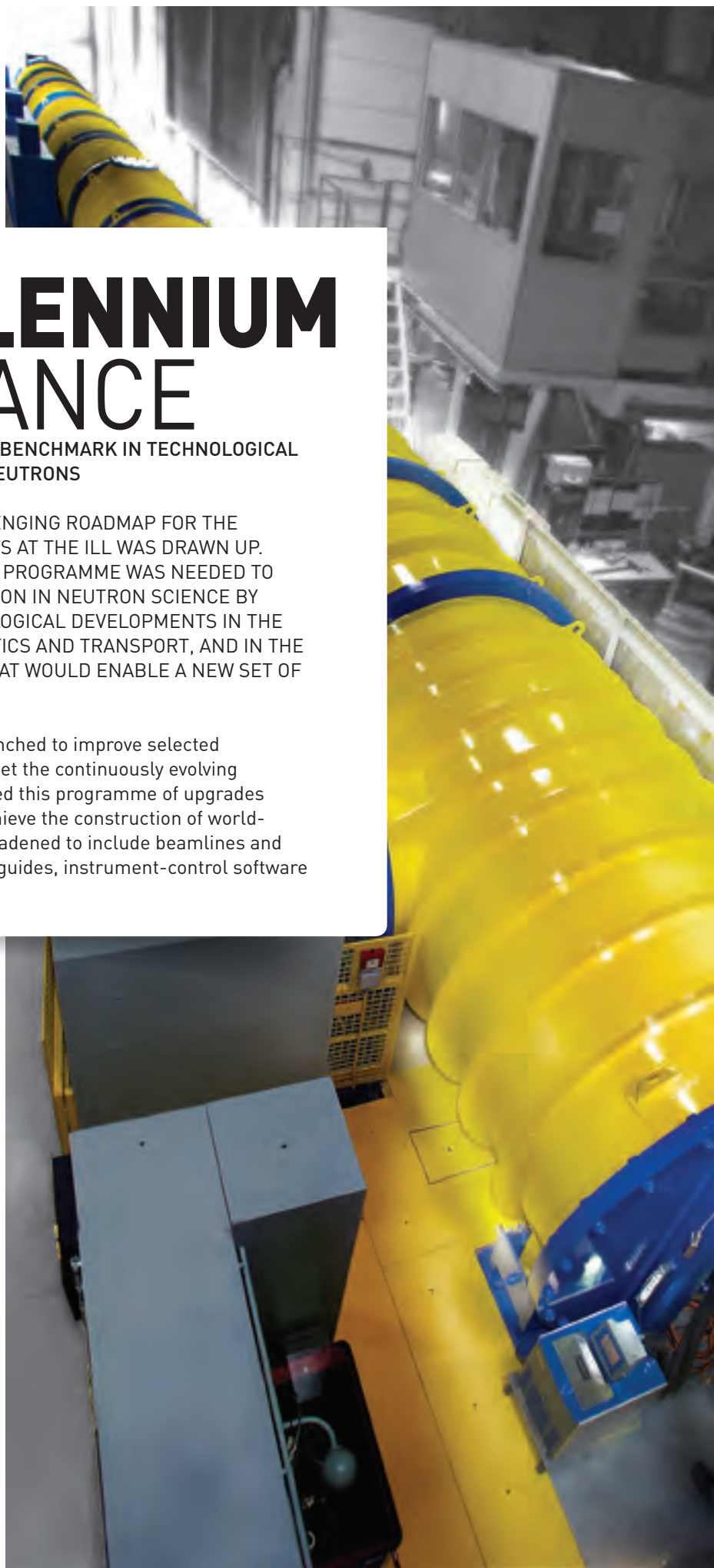



All the reflectometers have been renovated as well, with improvements for D17 and SuperAdam, following the construction of the horizontal-surface instrument FIGARO. This new set of instruments is dedicated to the study of thin films and magnetic multilayers in both hard and soft-condensed matter.

WASP, a high intensity spin-echo spectrometer replacing IN11, and ThALES, a cold-neutron triple-axis spectrometer (TAS) replacing IN14, are currently under construction, taking advantage of the renovation of the H5 guide system. This work will also benefit other instruments sited on the same beamline. WASP will address the investigation of the dynamics of soft matter and bio-materials, while ThALES, benefitting from an increased flux and kinematic range compared with IN14, will be dedicated to research on magnetic excitations, especially in correlated-electron systems. Another cold-neutron TAS, the CRG instrument IN12 – which has been moved to the renovated H144 guide and improved – will extend studies in this field.

The backscattering spectrometer, IN16, has been relocated and boosted, giving birth to IN16B, which should soon be confirmed as a world-leading instrument devoted to the study of the structure and dynamics of soft materials.

IN4, a thermal-neutron TOF instrument, has been upgraded so as to afford a much greater sensitivity, allowing it to be used to characterise molecular motions and vibrations, as well as magnetic excitations, in materials operating under everyday conditions.

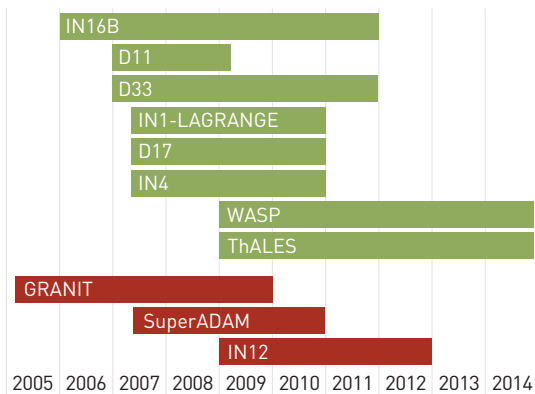

The timeline for the Millennium Programme

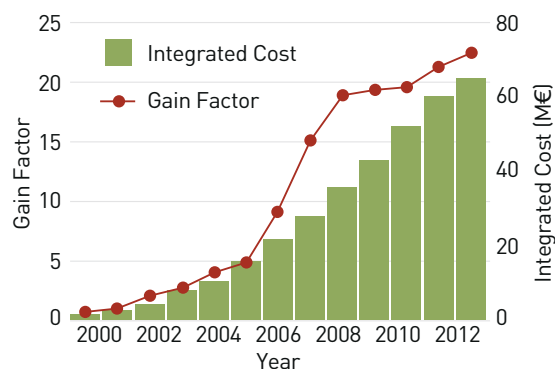

The gain factor in neutron count compared to the invested money in the Millennium Programme

The construction of the second-generation ultra-cold-neutron gravitational spectrometer, GRANIT, allows the study of quantum-gravity states.

Finally, the LAGRANGE project has made possible to increase greatly the sensitivity of the beryllium-filter configuration of the hot-neutron spectrometer IN1, for the study of hydrogen-containing materials and compounds.

A REAL INCREASE IN NEUTRON COUNT

In general terms, concentrating more neutrons on a sample by improving the guides and focusing optics, detecting more neutrons with more efficient detectors, selecting neutrons through adapted designs, we have been able to provide, with a limited amount of money, a real increase in neutron count at the detectors to enable both more experiments to be delivered and better science in each experiment.

A total budget of EURO 75 million (2001–2013) has been dedicated to the Programme, EURO 29 million for the M0 phase (2001–2008) and EURO 46 million for phase M1 (2008–2014). In phase M0, a global gain factor of 17 was already achieved, and by the end of phase M1, it had increased by up to 25 times. In addition, the staff of ILL has contributed hugely to this programme, providing a great deal of experience acquired in managing and handling complex and ambitious projects.

The Endurance project will closely follow in the footsteps of Millennium. It will provide new capabilities for currently emerging scientific areas, but equally will serve the domains that have not yet seen their full potential exploited under the Millennium Programme.

THE INSTRUMENTS SUITE UPGRADE:

A TECHNICAL PROGRAMME OVERVIEW

AFTER THE GREAT SUCCESS OF THE ILL MILLENNIUM PROGRAMME, A NEW INITIATIVE TO CONTINUE TO UPGRADE ILL INSTRUMENTS AND SCIENTIFIC INFRASTRUCTURE IS BEING PLANNED; IT IS BUILT ON THE SOLID FOUNDATION AND EXPERIENCE GAINED DURING THE WORK CARRIED OUT OVER THE PAST YEARS.

The Endurance Programme is dedicated to improving the performance, fitness and long-term potential of the ILL instrument suite. To achieve its scientific goals and open up new science, a challenging technical programme is being implemented to manage the design and construction of up to seven future world-leading instruments. In addition, seven existing instruments will be extensively modernised and four existing neutron guides completely re-designed.

The Endurance instrument vision cannot be separated from two ambitious companion programmes: NESSE – a vision for future sample environments, and BASTILLE – a new approach to data treatment. These will be put in place during the Endurance programme.

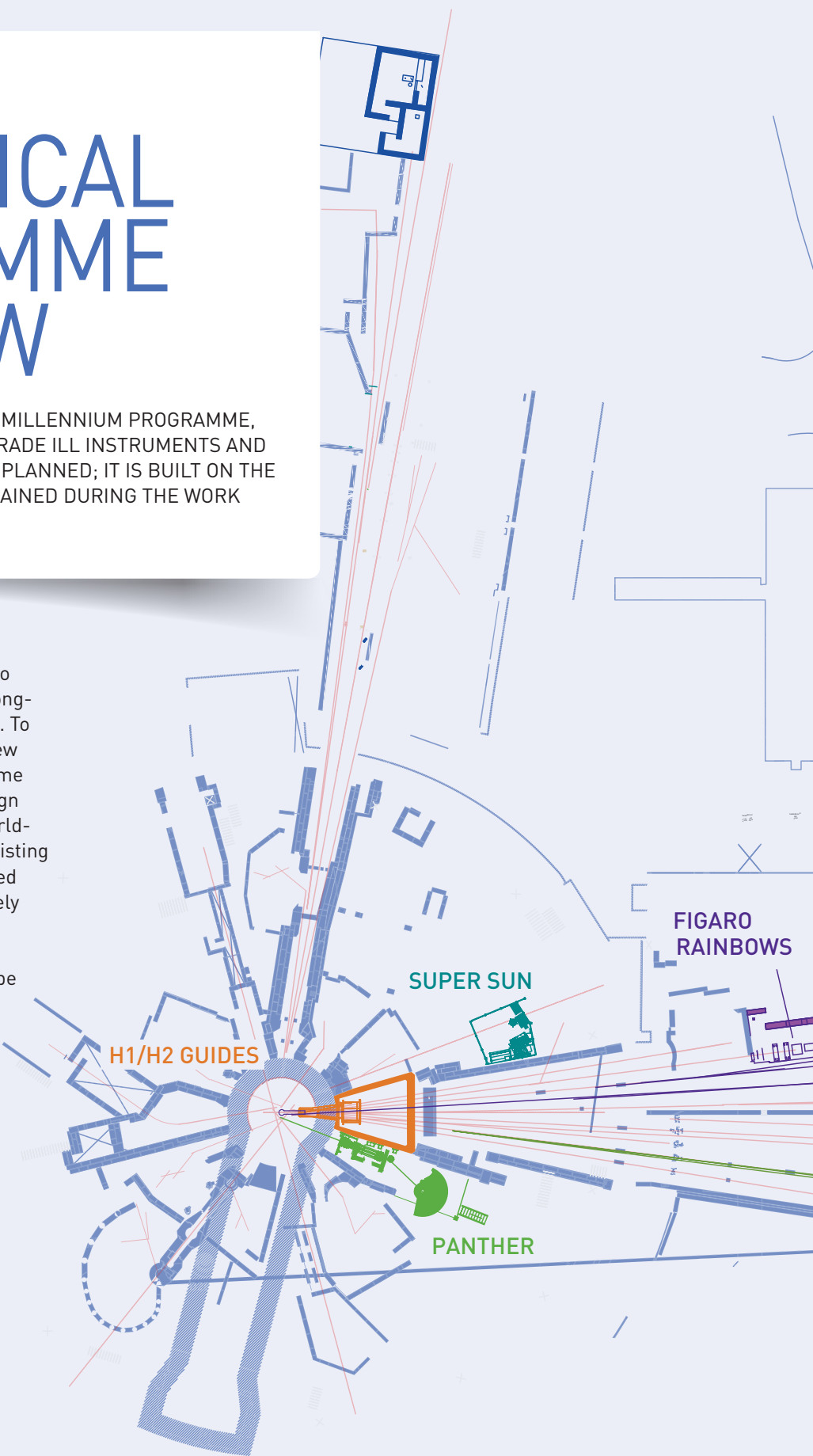

The programme is divided into projects as follows:

THE CHARTREUSE AND VERCORS ENSEMBLES

The existing four neutron guides relevant to these projects were installed just over 40 years ago. Their replacement by state-of-the-art neutron distribution systems will provide optimal experimental areas for four new instruments and will boost the performance of four other refurbished ones. The new guide systems will provide additional capabilities for

the implementation of instruments that are under evaluation following the Scientific Council advice (Phase II), as well as better neutron beams for technical instruments used for advanced R&D on detectors and neutron optics.

In both the Vercors and Chartreuse projects, a typical gain factor of two to four is expected from the guides installed upstream of each instrument depending on the instrument acceptance of the beam divergence.

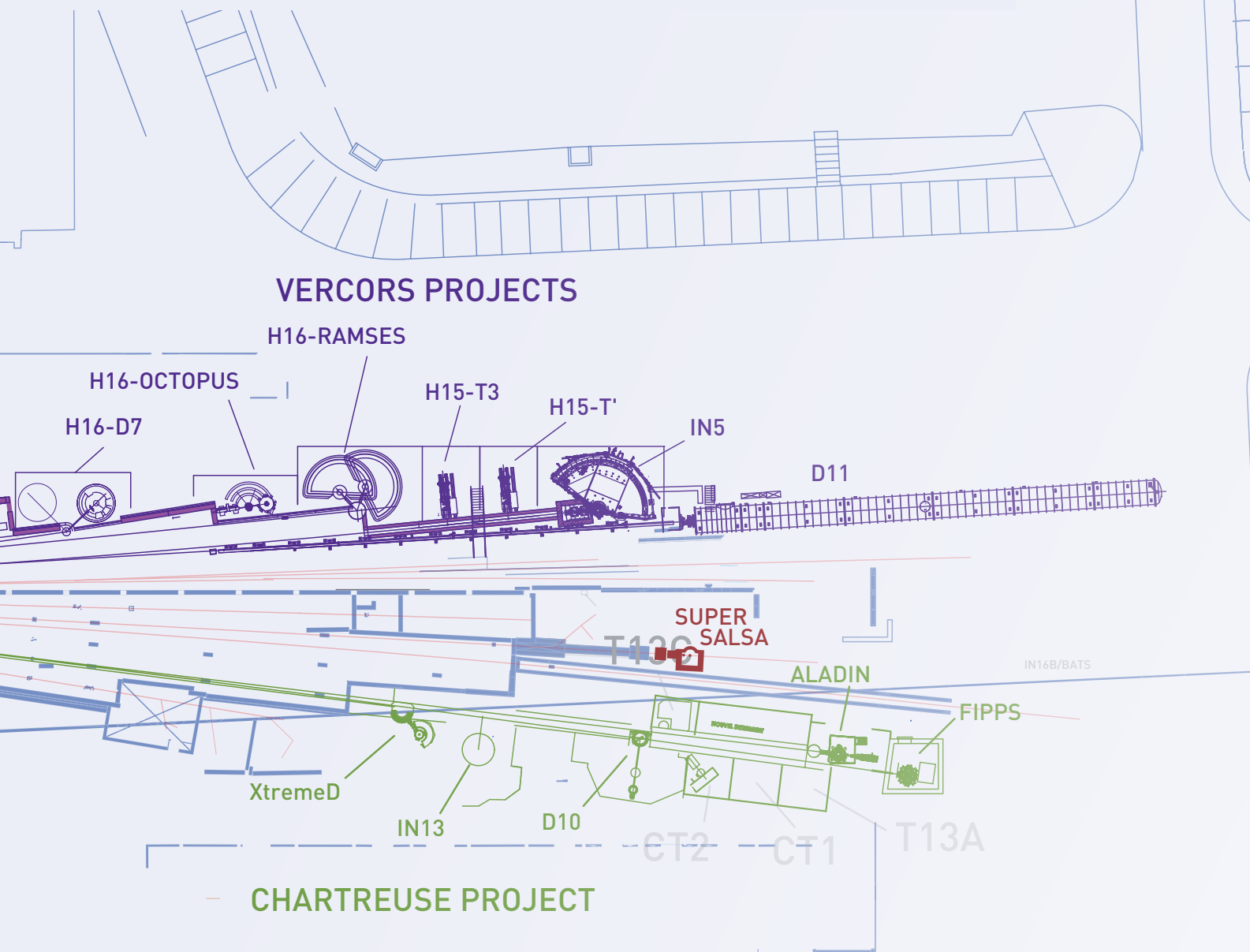

The position of the instruments once the entire programme (Phase I and Phase II) is completed

INSTRUMENT SITES TO BE PROVIDED BY THE VERCORS AND CHARTREUSE PROJECTS

CHARTREUSE	VERCORS
Neutron guide H23 – H24	Neutron H15 – H16
XtremeD : a dedicated guide will provide the high-intensity beam required.	RAMSES : will take the place left by the IN6 decommissioning.
FIPPS : a dedicated area and casemate are provided.	RAINBOWS–FIGARO : installation of the RAINBOWS and GISANS option on FIGARO.
D10* : higher neutron flux for the upgrade of one of the ILL's most productive instruments.	IN5* : an extension of its incoming spectrum to shorter wavelengths and minimisation of the fast-neutron background.
IN13 (CRG) : the modernised guide will provide the input for a refurbishment already investigated some years ago.	D7* : better performance by optimising the sample–monochromator distance and an in-guide polarised beam.
FURTHER INSTRUMENTS: PHASE II PROJECTS UNDER EVALUATION	
ALADIN : a dedicated guide section will provide the required pure white beam.	OCTOPUS : the new outline of the H15–H16 guides will provide a position for this instrument.

TECHNICAL INSTRUMENTS

T13 A/C: R&D for neutron optics.	RADIATION FACILITY : industrial applications.
CT1/2: R&D for neutron detectors.	T3: R&D for neutron optics (coating).

THE VERCORS SIDE

To create the desired beam position on the H15 and H16 guides, a slight offset of the existing guide axis will be implemented. The cold guide casemate in the ILL7 guide hall will be entirely redesigned; however most of the shielding material will be reusable. The combination of an optimised configuration of the guide geometry and supermirror coatings will ensure the highly efficient transport of neutrons towards the future experimental areas – as is confirmed through McStas simulations.

H15 will be split into three branches: the tallest one will increase the flux and widen the spectra for IN5*; the second one will provide a wider low-divergence beam for D11; and the last will be used for technical instruments.

H16 will be shared between two branches of comparable size – optimised for RAMSES and D7*. The choice of supermirror coating used upstream will guarantee the best neutron filling of the guide, as required by RAMSES and D7*.

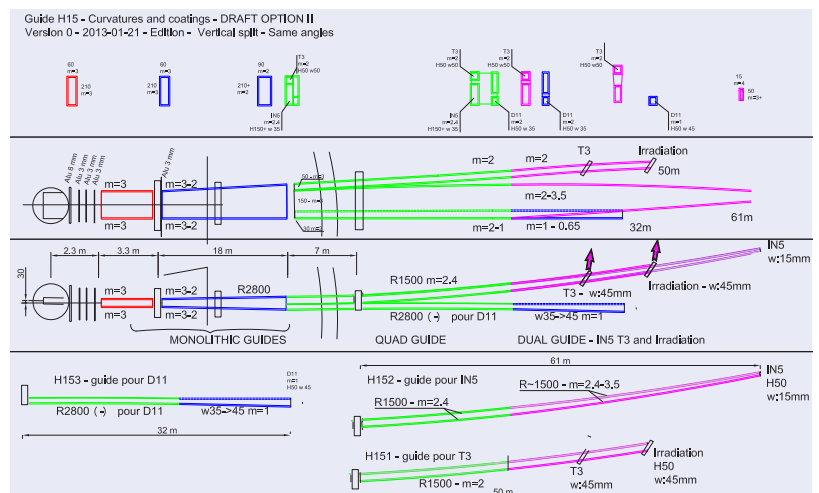
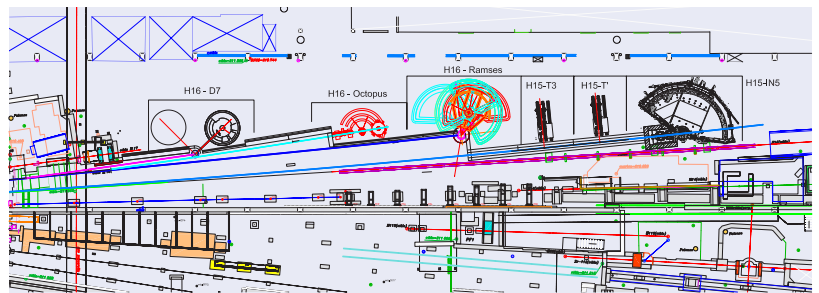
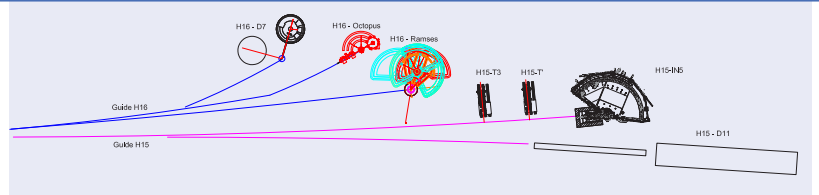

The H15 and H16 preliminary layout showing the physical implementation in the ILL7 guide hall (top and middle) and neutron transport design (bottom)

THE CHARTREUSE PROJECT

To exploit better the restricted space around H23 and improve the efficiency of neutron transport, the two guides, H24 and H23, will be joined from the moderator in a single beam section, and split further downstream to minimise the background of fast neutrons at the instruments. The first branch after the split will be dedicated to XtremeD. The second branch will be separated in the vertical direction: the lower part bringing neutrons to IN13 and D10*, while the upper part will be shared between FIPPS, ALADIN and a new instrument. In addition, technical instruments will take the best from remaining areas and beams.

Sufficient separation between the branches is obtained by using proper curvature radii and guide coatings. Some branches will retain a similar curvature to the present value, which will make it possible to implement the upgrades in several steps, keeping operational instruments currently positioned on the H24 guide.

The H24 and H23 preliminary layout showing the physical implementation in the ILL7 guide hall (top) and neutron transport design (bottom)

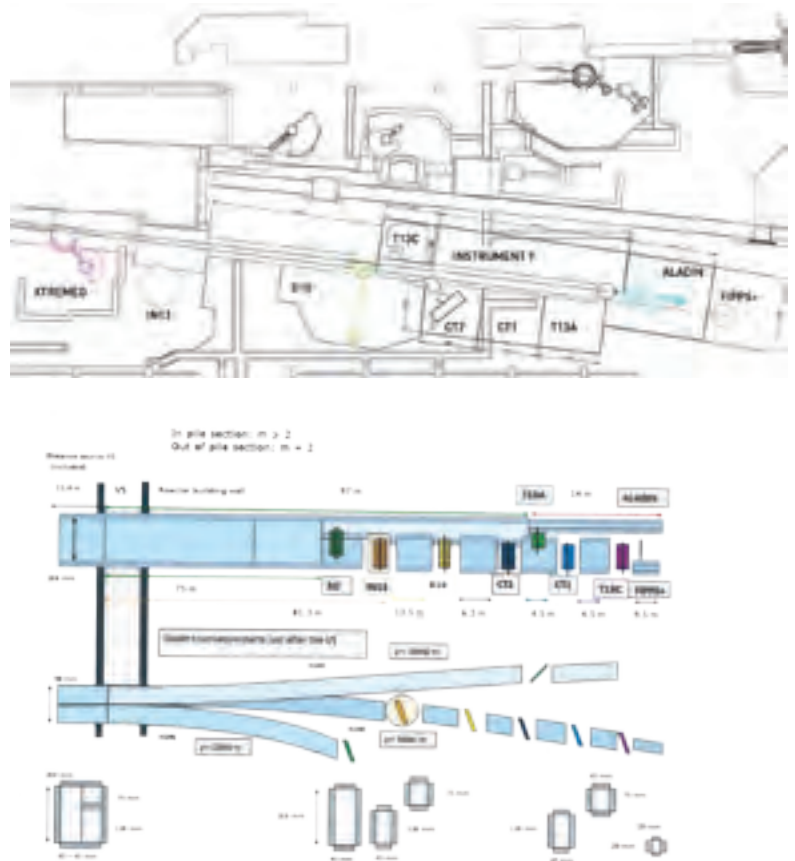

SINGLE INDEPENDENT INSTRUMENT PROJECTS

The new PANTHER instrument will replace IN4 at the same beam position. SuperSUN in Phase I aims to increase the available ultra-cold neutron density on the current position in the reactor hall.

The proposed upgrade of the SALSA to SuperSALSA (Phase II) will result in a more versatile and complete instrument on the existing guide position.

Finally, the triple-axis instrument, exTAS, is in a prototype stage. Its siting will be decided once all design parameters are known (Phase II).



IMPLEMENTATION

Endurance is an ambitious upgrade programme. It requires a careful analysis of the necessary time, budget and manpower. The result is that the Endurance programme will be implemented following the strict management principles that were so successfully applied to Millennium.

The work will be scheduled in such a way that the negative impact on the operation of the ILL instrument suite is minimised. Special attention will have to be given to any interference between the various project components.

Once there is clarity about the financial profile available for implementing Endurance, the first stage of the project will be devoted to making the final decisions on instrument siting and technical choices through a series of meetings and workshops involving technical experts and scientific users. They will then be finalised in the Endurance Master Project Plan, which lays out step by step the concrete implementation of Endurance. The experience accumulated in the past allows the ILL to indicate with great confidence that the proposed upgrades will be delivered as promised in the Project Plan.



FIPPS

A NEW HIGH-RESOLUTION SPECTROMETER FOR STUDYING EXOTIC NUCLEI

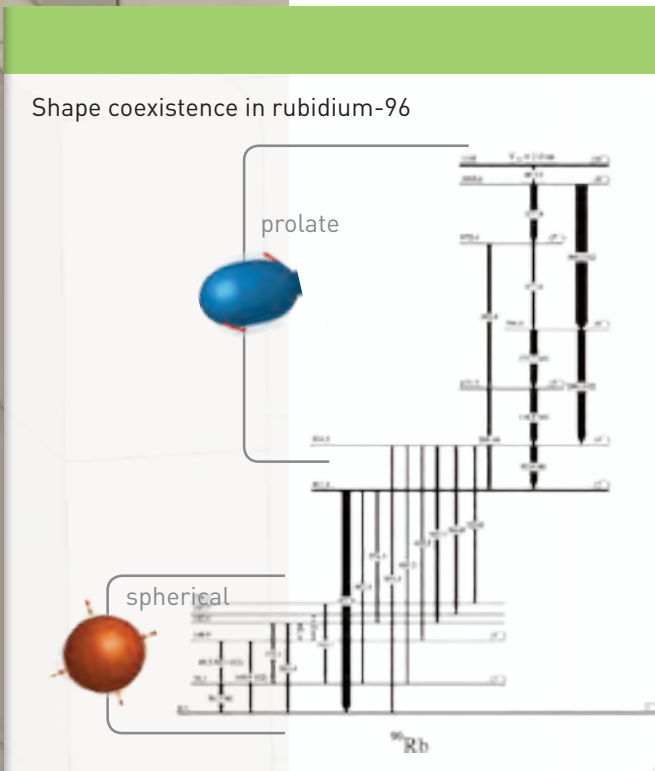
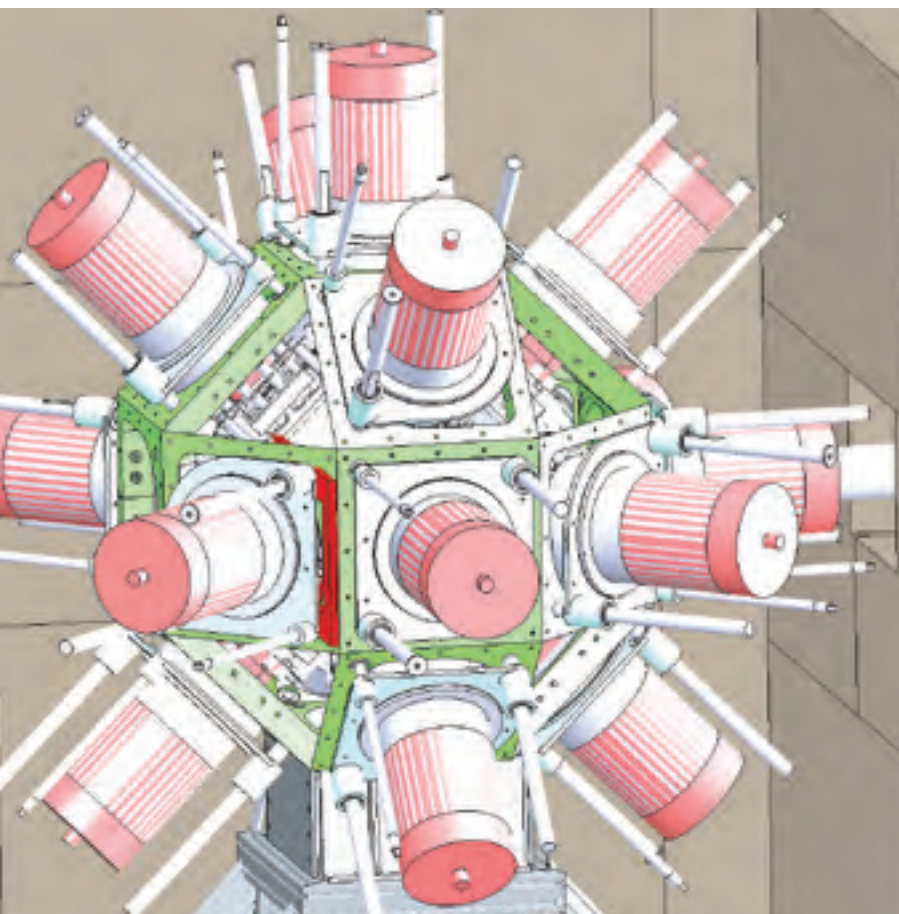

Our knowledge of the atomic nucleus is far from complete. It has been gleaned largely from studies of nuclei found on Earth that are stable enough to have survived from the time when they were created in the interiors of stars via nucleosynthesis. However, thousands of kinds of atomic nuclei can exist that are much shorter-lived. Many of them contain larger proportions of neutrons than are found in stable nuclei, and are thought to be transiently generated during the processes of stellar nucleosynthesis, playing a significant part in building up the familiar elements that compose us and our terrestrial environment.

These exotic nuclei can also be made via nuclear reactions using particle accelerators and nuclear reactors. Their study provides a crucial way of probing the forces that hold nuclei together and control their structure, shape and stability – as well as exploring their role in nucleosynthesis and thus the evolution of the Universe.

The intense neutron source of the ILL provides a route to creating neutron-rich nuclei by inducing the low-energy fission of actinide targets. The hundreds of nuclear fragments produced can be identified and characterised using germanium detectors, which record the energies of the cascades of gamma-rays emitted by the excited nuclei. The resulting gamma-ray spectra provide information in exquisite detail regarding the nuclear energy levels that reveal their structure and properties.

Recently, more than 100 neutron-rich fission nuclei were investigated at the ILL during the 'EXILL campaign', in which the high-performance EXOGAM germanium detector array normally installed at the GANIL nuclear physics centre in Caen, France was temporarily transferred to the ILL. The cascade of a particular fission fragment could be constructed by picking out multiple gamma-rays that arrive in coincidence at the detector array. However, this approach works best for identifying nuclei produced in relatively large yields.

NEW SCIENCE

■ Shape coexistence

A typical example of a nuclear structure study is the investigation of how the shape of the nucleus evolves as more and more neutrons are added. For example, the element rubidium (with 37 protons) has two stable isotopes with 48 and 50 neutrons respectively. When more neutrons are added, initially the ground state of the nucleus remains rather spherical. However, in increasingly more excited states, it starts to deform into a prolate shape. When 59 neutrons are reached, there is a sudden dramatic transition to favour deformed ground states. The result is a wealth of different shapes for this nucleus.

FIPPS has the potential to push such studies to higher excitation energies and to even more neutron-rich nuclei such as the still heavier rubidium isotopes, or elements with fewer protons.

The detection of more exotic, rarer nuclei could be achieved via another approach suited to the ILL reactor. Fission results in two fragments being emitted back to back, and a more efficient way of identifying a given fragment and assigning a gamma-ray spectrum to it would be to identify its fission partner simultaneously by measuring its mass and nuclear charge with a suitable spectrometer.

The ILL is planning to do just that with a novel combination setup – FIPPS (Fission Product Prompt gamma-ray Spectrometer). It consists of a new germanium detector array with a large efficiency, which carries out high-resolution gamma-ray spectroscopy, combined with a dedicated gas-filled spectrometer that can identify the second fragment with a large acceptance. Such a setup will open up unprecedented possibilities for studying the spectroscopy of exotic nuclei at the ILL.

Theories predict that for neutron-rich isotopes with just three protons less (selenium), yet another nuclear shape might occur: a stable octupole deformation resulting in a pear-shaped nucleus. Such shapes were known from actinide nuclei and were recently observed in radium nuclei at ISOLDE-CERN, but the neutron-rich selenium isotopes were, so far, beyond experimental reach and require a new, more efficient instrument such as FIPPS.

■ Nuclear energy

In addition, several other key open questions could be addressed by FIPPS: the fission mechanism itself; the measurement of fission isotopic yields; and the studies associated with the design of new nuclear reactors (Generation IV reactors and those based on the thorium cycle).

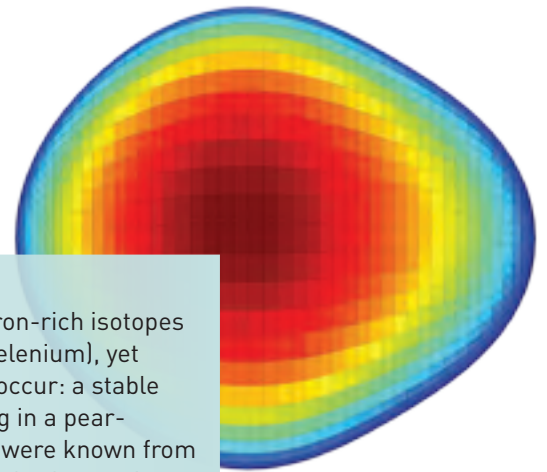

FIPPS may find more pear-shaped nuclei similar to the radium-224 nucleus recently discovered at CERN

THE UPGRADE

■ FIPPS consists of a high-efficiency germanium detector array, surrounding a fission target that is half open but has a thick backing, a time-of-flight (TOF) measurement system and a gas-filled spectrometer.

■ The first fragment will be stopped in the target backing, and the gamma-rays from its decay will be detected with the germanium detectors. In addition to spectroscopy, useful information such as excitation energy, spin or angular correlation can also be extracted.

■ The second fragment will fly through the open side of the target to the gas-filled spectrometer. Two TOF detectors, located close to the target and at the entrance of the spectrometer, will measure the fragment's velocity. The FIPPS spectrometer is based on a new concept combining a gas-filled magnet and a time-projection chamber for individual 3D tracking of the fragments. The angular acceptance of the spectrometer can therefore be maximised without compromising the mass resolution. This unique instrument, in combination with the TOF measurement, will allow the mass and kinetic energy of the second fission fragment to be identified.

PROJECT TEAM:

ILL:

A. Blanc
A. Chebboubi
H. Faust
M. Jentschel
U. Köster
W. Urban

LPSC:

G. Kessedjian
C. Sage
G. Simpson

COST:

EURO 3 million

ESTIMATED

PROJECT DURATION:

2 years for installation at H22, then relocation to H24 guide

SuperSUN

A WORLD-BEATING SOURCE OF ULTRA-COLD NEUTRONS FOR EXPERIMENTS IN FUNDAMENTAL PHYSICS

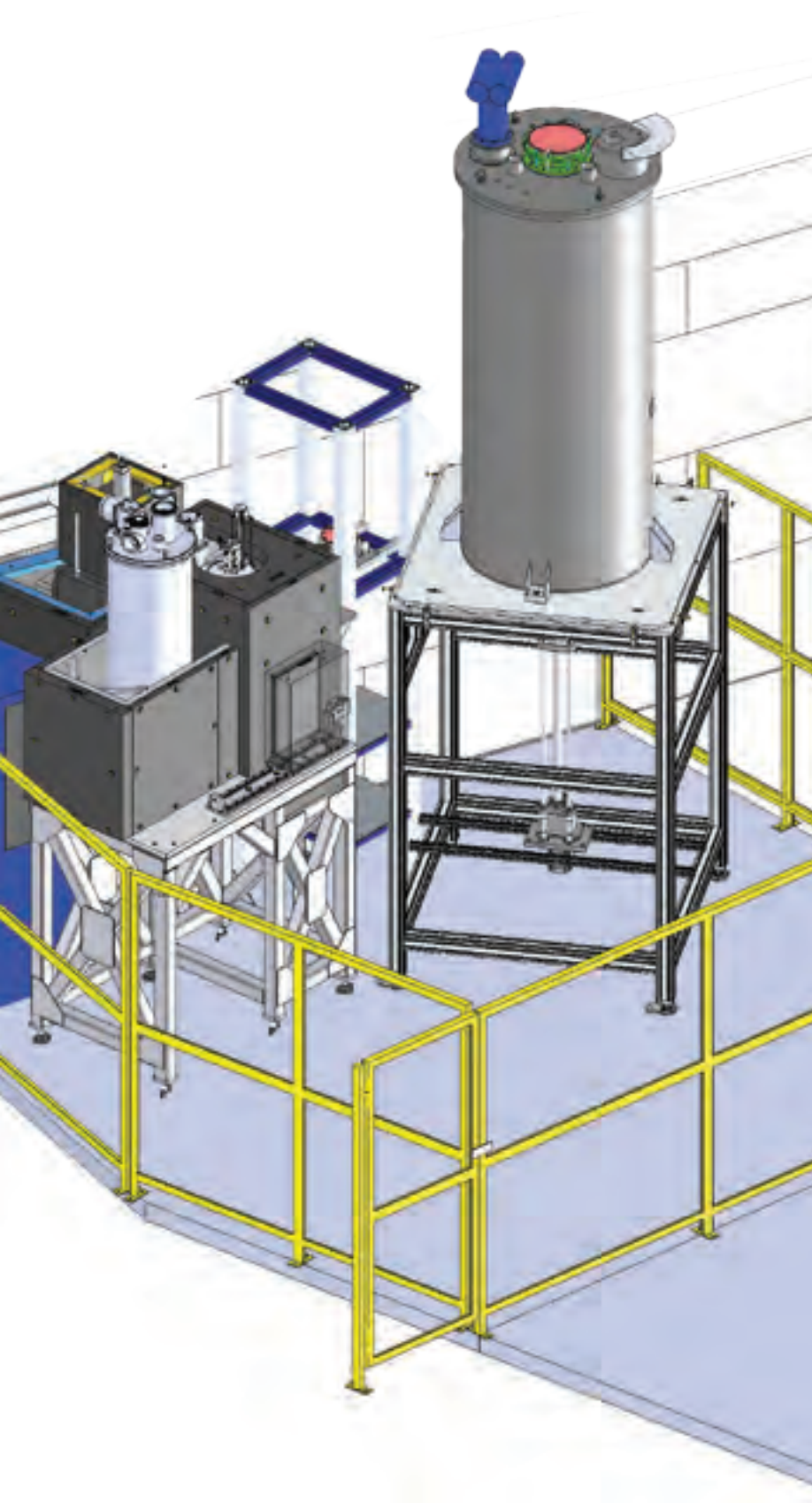

Part of the equipment for measuring the neutron electric dipole moment

THE SCIENCE

The Standard Model of Particle Physics has been extremely successful in describing virtually every known process among elementary particles. However, it is currently unable to explain basic facts that are important for our own existence, in particular why there is such a large excess of matter over antimatter in the Universe. The fundamental building blocks making up matter and the forces are thought to have come into existence during a series of phase transitions as the hot, primordial Universe cooled just after the Big Bang. Driven by the highly non-equilibrium conditions that existed at this epoch, certain processes marking those phase transitions must have generated the matter-antimatter asymmetry we see today.

Physicists have been investigating what these processes could be – in particular, interactions in which symmetries in the behaviour of particles and antiparticles might be violated. These relate to charge conjugation, parity (mirror image) and the direction of time. Sensitive experiments might probe new interactions able to generate the observed matter-antimatter asymmetry, notably if they occurred in the epoch when weak and electromagnetic interactions emerged as distinct forces. Such experiments involve two complementary strategies: one is looking for new interactions at very high energies, as explored in the Large Hadron Collider (LHC) at CERN; the second is making precision measurements on particles at very low energies. The neutron is one such particle, and ILL is at the forefront of performing neutron experiments to explore symmetry violations and behaviour not covered by the Standard Model.

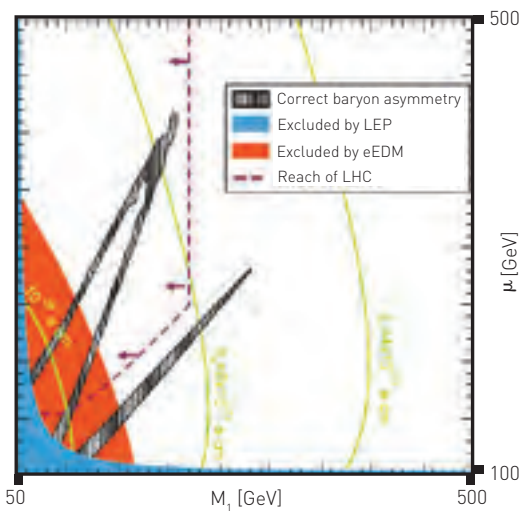

One of the most sensitive methods of testing for violation of fundamental symmetries at the precision frontier is to search for electric dipole moments (EDM) of elementary particles. This approach could provide evidence for new phenomena relating to the creation of matter that would not be observed with the LHC, as shown in the figure above for an extension of the Standard Model known as the minimal supersymmetric model.

The ILL has been the place for most sensitive searches for the neutron EDM (nEDM) for many years. The current best result was produced several years ago using the ILL's user source,

Regions of the mass parameter space of minimal supersymmetric model of particle physics consistent with electroweak baryogenesis. The shaded regions are those that would lead to the observed matter-antimatter asymmetry of the Universe. The region for mass parameters $M\mu_1$ that govern the character of the neutralinos is accessible only with nEDM searches [Ramsey-Musolf, *NIM A*, 611, (2009) 111]

THE SUPERSUN UPGRADE

A first step in improving the UCN density was achieved at the ILL with a prototype employing a converter of ultrapure superfluid helium-4. Therein, cold neutrons with energy of about 1 meV may excite single vibration quanta of the liquid and thus become ultracold. The converter vessel must have reflective walls with low losses so that UCN can become accumulated to high density. With the prototype, a world-leading neutron density of 55 per cm^3 has been obtained – which in the meantime has been more than doubled with an improved apparatus. However, still too many neutrons are lost through interactions with the vessel walls, limiting the UCN density that can be reached during accumulation.

In SuperSUN, a sheath-like magnetic multipole reflector around the converter will deflect neutrons away from the walls so that storage time constants approaching the neutron lifetime of about 880 s become possible, leading to a dramatic improvement of the UCN density beyond 1000 per cm^3 . As a very welcome feature, which perfectly suits notably the EDM search but also any magnetic trapping experiment, the source will provide fully polarised UCN since those neutrons with spin pointing in the wrong direction will be attracted by the magnetic field towards the vessel wall and quickly get lost. In a staged approach, SuperSUN will first be installed at an existing monochromatic beam and in a later phase of the project moved to a dedicated white-beam position, which should increase the UCN density by a further factor of five.

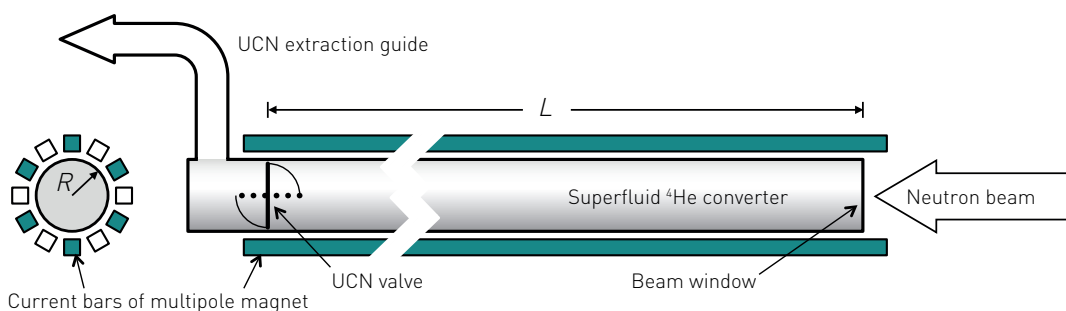

Schematic of the SuperSUN UCN accumulator comprised of a superfluid helium-4 converter with 12-pole magnet and system for UCN extraction. On the left, a cut view is shown through the coils of the magnet; filled (open) squares indicate electric current flowing into (out of) the plane (size dimensions: $R = 5 \text{ cm}$, $L = 3 \text{ m}$)

PF2, for ultra-cold neutrons (UCN). This measurement gave a value consistent with zero at a precision sensitivity of $3 \times 10^{-26} \text{ ecm}$ – a result that has ruled out more new particle physics theories than any other experiment. (The Standard Model predicts a value of 10^{-31} – 10^{-32} ecm , but supersymmetric theories predict much larger values in the range of 10^{-25} – 10^{-28} ecm). To exclude or support scenarios such as the one shown in the top figure, the sensitivity needs to be increased by at least an order of magnitude. This calls for new UCN sources with much higher densities of neutrons.

Current UCN densities available at the ILL – which are, at best, only a few tens of neutrons per cubic centimetre – limit also other studies in fundamental physics, such as those of the weak interaction of the nucleon, as investigated through precision measurements of the neutron lifetime and asymmetries in its decay. Searches for new gravitational interactions and other forces at micrometre distances would also profit from a significantly improved UCN source.

ILL PROJECT TEAM:

P. Geltenbort
S. Ivanov
M. Kreuz
F. Martin
O. Zimmer

ESTIMATED COST:
EURO 1 million

ESTIMATED PROJECT DURATION:
3 years

IN5⁺ TIME-OF-FLIGHT SPECTROMETER: SEEKING OUT GOOD VIBRATIONS

Much interesting dynamic behaviour at the atomic and molecular scale, such as molecular vibrations, and magnetic and quantum fluctuations, occurs at low energies (millielectronvolts) or equivalently over picosecond timescales (10^{-12} s). This is why time-of-flight spectrometers such as IN5 have been workhorse instruments at the ILL and elsewhere since the first development of neutron spectrometry. In addition, this kind of instrument is not restricted to experiments in one scientific field; a wide range of successful experiments have been carried out on IN5 – from the elucidation of the protein–water interactions in biophysical studies, through analysis of the behaviour of glassy materials, to the exploration of spin-coupling mechanisms in magnetic systems.

In recent years, the IN5 spectrometer has been improved: the chopper system, flight chamber and detectors have been upgraded with state-of-the-art technology. In particular, the cylindrical detector bank, which is composed of fully pixelated position-sensitive detectors, now allows measurements to be made on single crystals over a wide range of angles (as for a triple-axis spectrometer) – whereas previously, users were limited to working with amorphous, liquid and polycrystalline (powder) samples. The ability to map precisely a broad range of excitations in single crystals has revolutionised investigations of many compounds, including, for example, those with complex magnetic behaviour such as single-molecule magnets or quantum solids such as helium in its crystal phases.



The time-of-flight chamber

Despite these successes, recent experience with IN5 has suggested further potential for improvement within the Endurance project. For studies of phonons (lattice vibrations), the scattering vector (Q) range available is rather limited, while for magnetic systems, slightly higher-energy incident neutrons would allow the measurement of low-temperature excitations such as magnetic spin waves or the subtle changes in electronic energies due to structural variations. Furthermore, the instrument is rather close to the reactor, with the result that the ambient neutron background masks the very weak scattering signals seen in some quantum materials.

In addition to increasing the neutron flux by installing a state-of-the-art guide, the signal-to-noise ratio could be further improved by moving the instrument approximately 30 m downstream. In such a position, it would receive fewer of the epithermal neutrons that constitute the major part of the ambient background.

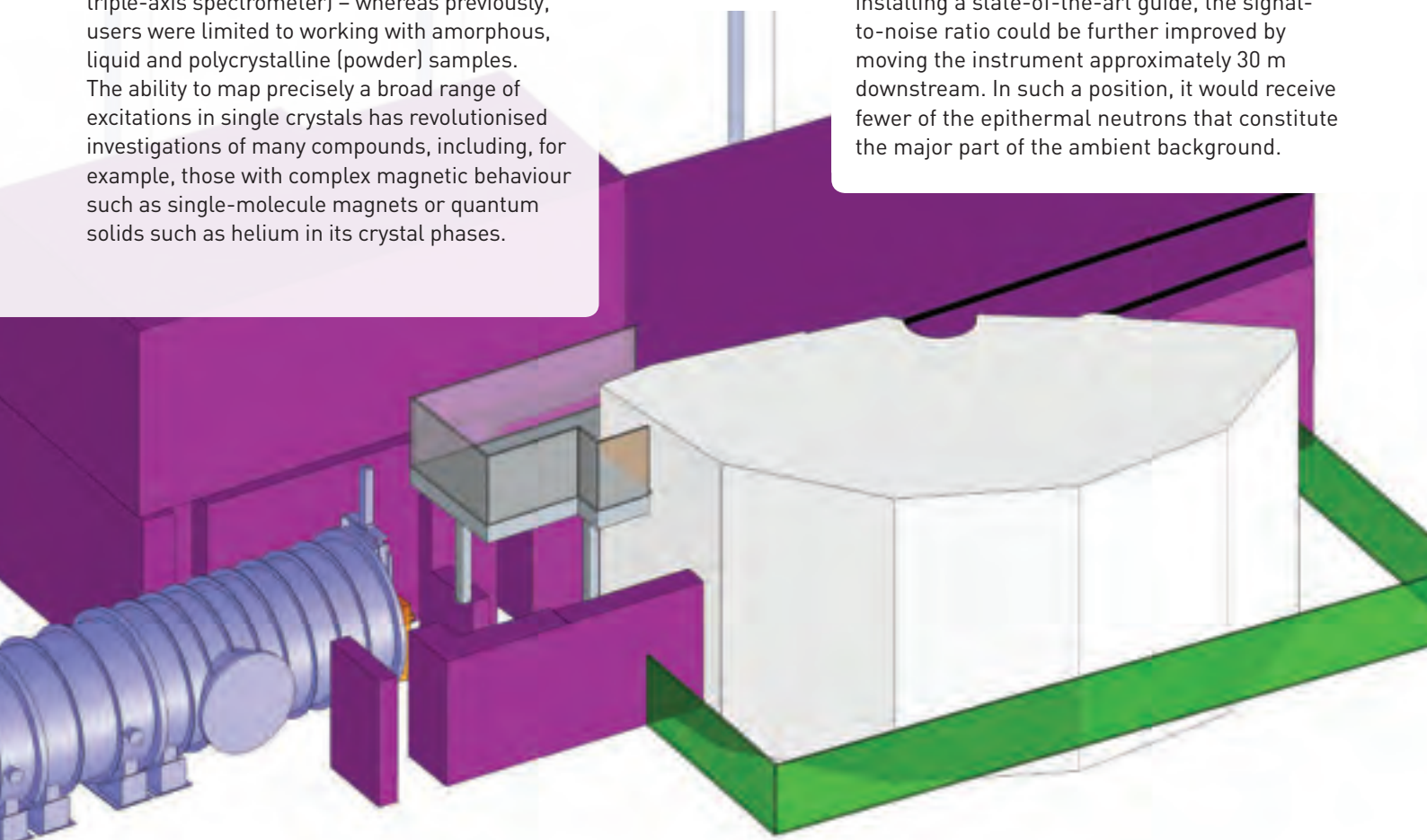

RECENT SCIENCE SUCCESSES

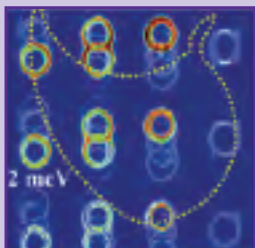

Spin waves in iron langasite
[Loire et al., PRL, 2012]

Spin waves in single crystals

The iron langasite ($\text{Ba}_3\text{NbFe}_3\text{Si}_2\text{O}_{14}$) has attracted attention because of its unusual magnetic structure. The magnetic iron (Fe^{3+}) ions are arranged in a triangular lattice, which leads to complex magnetic coupling that has the potential to generate magnetoelectric/multiferroic behaviour at low temperatures. Single-crystal experiments on IN5 enabled all of the magnetic excitations of the structure to be mapped for the first time.

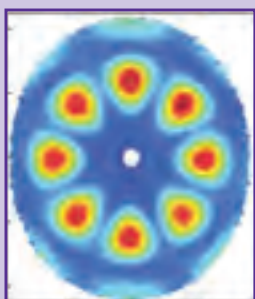

A wave vector map for Cr_8
single molecule magnet
[Baker et al., Nat. Phys., 2012]

Molecular nanomagnets

With the availability of large enough single crystals, the new position-sensitive detectors have completely revolutionised studies of single molecular magnets, whose discrete coherent spin behaviour is of interest in quantum computing. The spin dynamics characterising a model antiferromagnetic molecular ring of eight chromium ions (Cr_8) could be extensively analysed, which would have been difficult using powder samples.

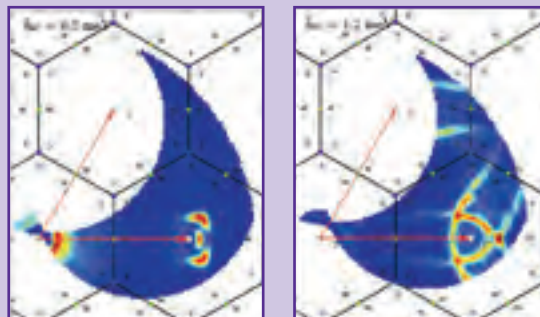

Phonon dispersions in hexagonal helium [J. Ollivier et al., unpublished, 2013]

Hexagonal helium

One of the earliest and most studied quantum solids, hexagonal helium-4 (temperature below 1 K and pressure above 2.5 MPa), has been re-investigated. Once the technical challenges – those of growing and orienting a large perfect single crystal – were overcome, we could see the phonon dispersions characterising this material in unprecedented detail.

FUTURE SCIENCE

Helium-3 layer on graphite

Helium-3 below 1 mK provides a model system for understanding the excitations of strongly interacting fermionic (nuclear spin 1/2) quantum fluids. Inelastic neutron-scattering experiments on a 2D layer of helium-3 (on graphite) provides a way of investigating its fundamental quantum behaviour. Hitherto, it has proved difficult to collect good data because neutrons are readily absorbed by helium-3. The higher neutron flux with a lower background afforded by the upgrade of IN5 will provide much better statistics and resolution.

Materials for energy generation

Skutterudites, compounds composed of a rare-earth metal, a transition metal and a metalloid (phosphorus, antimony or arsenic), are currently of great interest because of their thermoelectric properties that could be exploited in waste-heat recovery. Single-crystal studies of skutterudites would allow their thermal properties to be explored via analysis of the phonon dispersion.

THE UPGRADE

A new guide will be installed to give:

- An increase in neutron flux at the sample position through better transport of the neutrons and an improved guide geometry.
- An extension of the energy range of the incident neutrons towards shorter wavelengths by using state-of-the-art supermirror guides along the beamline, so minimising losses for warmer neutrons.

This guide improvement will allow the use of incident wavelengths down to 1.5 Å (35 meV) where the gains are maximised. With a relocation of the instrument to a position downstream from its present one, a reduction of the background originating from reactor epithermal neutron leaks (expected to decrease more than linearly with the distance to the reactor), will give a further gain in terms of signal-to-noise ratio.

PROJECT TEAM:

J. Ollivier
H. Mutka
L. Didier
B. Giroud
J. Beaucour

COST:

EURO 2.4 million

ESTIMATED PROJECT DURATION:

4 years

RAMSES

A NEW SPECTROMETER FOR STUDYING ADVANCED MATERIALS IN EXTREME ENVIRONMENTS

Time-of-Flight (TOF) spectroscopy is the workhorse experimental technique for studying the microscopic dynamics of complex materials. TOF spectrometers can cover a wide range of energies and momenta, and offer a high flexibility in terms of dynamic range and energy resolution. For these reasons, TOF spectroscopy covers many different research topics in physics, ranging from studies of vibrational and relaxational dynamics in solids, through spin excitations in magnetic materials and high-temperature superconductors.

During the past few years, TOF spectroscopy has become a vital probe in other scientific disciplines, such as chemistry, the geosciences, and materials research relevant to industrial engineering and energy supply – as well as the life and environmental sciences. As a result, demands for neutron beams with particular characteristics and specialised sample-handling have become urgent.

For example, the monitoring of fast chemical reactions and catalytic processes calls for a very high neutron flux. Engineering-materials research frequently requires high temperatures for experiments that simulate operating conditions. In the geosciences, it is essential to be able to combine high pressures with either low temperatures, as found in planetary objects, or high temperatures as exist deep in the Earth's mantle.

The application of extreme experimental conditions poses strong limitations on the sizes of the samples. The levitation and laser-heating devices for high-temperature studies, as well as the Paris–Edinburgh cells (PEC) for high-pressure experiments, accept volumes of only about 10 mm³.

Over the past decade using the IN6 TOF spectrometer, we have demonstrated that experiments under extreme conditions and with small sample volumes are feasible with such instruments. However, the sample material has to be optimised for the highest scattering power, and often experiments are feasible only with materials containing hydrogen. An increase of neutron flux by at least one order of magnitude would allow us to carry out extreme-condition experiments on any sample material. Today's cutting-edge experiments would become standard measurements and spectroscopic studies of specimens with volumes as small as 1 mm³ could become feasible.

RAMSES (Rapid Measurement and Specialised Environment Spectrometer) within the Endurance project, although primarily intended to meet the requirements of chemistry, geosciences, biology and materials science, will also serve other scientific disciplines solving important questions. It will be the successor to IN6, preserving its excellent signal-to-noise ratio, but outperforming its flux by at least 10 times and providing an extended energy-momentum range.

The structures of hydrogen-storage and carbon-capture materials will be important targets for RAMSES

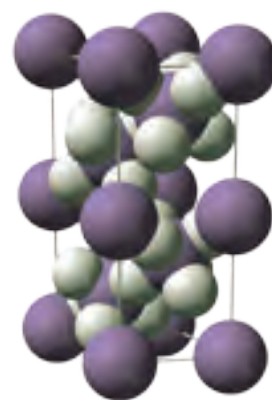

RECENT SCIENCE SUCCESSES

■ The changing states of ice under pressure

The complex phase transformations that water ice can undergo under pressure has been studied with IN6, and are intrinsically interesting because of water's unusual physical behaviour (it expands when it freezes). They are also of relevance in understanding the planetology of ice giants such as Neptune, Uranus and some exoplanets, which are thought to be composed of large amounts of water under extreme pressures.

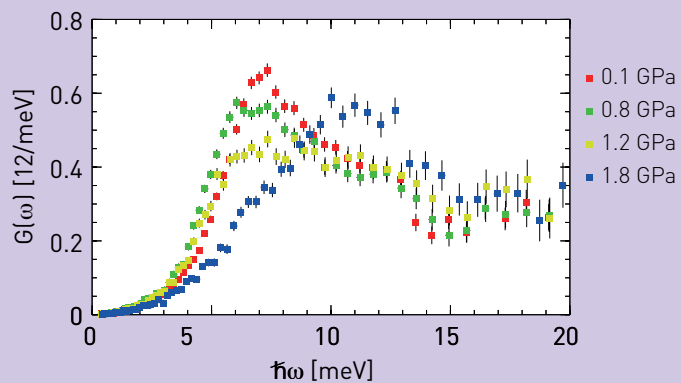

Generalised density of states $G(\omega)$ of ice I_h , amorphised at high pressures into a high-density amorphous modification. Studies are relevant to planetary ices

FUTURE SCIENCE

■ Extraterrestrial studies

Planetary materials under pressure could be studied much more extensively, for example, the behaviour of compressed hot water in the Earth's mantle is important in volcanic activity, and the properties of water, ammonia and methane ices in conditions present in extraterrestrial objects could be studied experimentally.

■ Hydrogen storage and carbon capture

Environmentally significant diffusion processes such as the adsorption of hydrogen fuel in hydrogen-storage materials could be measured under operating conditions, while studies of the capture of the greenhouse gas, carbon dioxide, by 'designer' porous solids would become feasible.

■ Magnetic frustration

Mixed metal minerals with complex quantum behaviour, such as the frustration of spin order due to competing magnetic forces, continue to intrigue, especially when it appears to be related to novel types of superconductivity. High-pressure, low-temperature studies would shed light on how their unusual properties evolve.

■ Heavy fermion metals

Unconventional superconductivity and magnetic behaviour are seen in so-called heavy-fermion metals, in which the conducting electrons are strongly interacting so behave as though they have an increased mass. These materials can show interesting quantum behaviour at very low temperatures. An example is uranium ruthenium silicide (URu_2Si_2), which could be further probed at these temperatures.



PROJECT TEAM:

M. Koza
M. Zbiri
S. Fuard

ESTIMATED COST:

EURO 7 million

ESTIMATED

PROJECT DURATION:

4 years

THE UPGRADE

■ RAMSES is projected to work with an incident neutron wavelength range of 2.5–6 Å.

■ It will be a hybrid TOF spectrometer equipped with a pyrolytic graphite monochromator and two choppers. A disc chopper located before the monochromator will be used for pre-shaping neutron pulses and reducing the background. A Fermi chopper located after the monochromator close to the sample position will define the energy resolution by shaping short pulses of a narrow bandwidth. By adjusting the phase between the two choppers, the order of the incident neutron

wavelength accepted by the monochromator can be selected.

■ The spectrometer optics will consist of a series of focusing and defocusing supermirror elements, forming a spot of 10 mm² with a homogeneous cross-section at the sample position. Monte Carlo simulations of RAMSES revealed a 20-times flux increase over IN6 in the spot. Dedicated optical elements for beam compression placed between the Fermi chopper and the sample can increase the flux in a 2 mm-high spot a further two to sixfold, depending on the wavelength.

PANTHER

A NEW THERMAL SPECTROMETER FOR STUDYING DYNAMICS IN COMPLEX SOLIDS

The ILL's only thermal neutron time-of-flight (TOF) spectrometer, IN4C, has been a key instrument for many users. It allows for fast, multi-scale surveys in novel materials of both theoretical and commercial interest, for example, those with interesting magnetic behaviour or potential for energy storage. The dynamical range offered by IN4C makes it particularly suited to measuring a wide range of relevant energetic phenomena. These include: fundamental excitations associated with structure, such as phonons, spin waves and molecular vibrations; and fast dynamical disorder such as the diffusion of atoms in solids, rotational dynamics and magnetic correlations. IN4C probably has the highest flux of any such instrument in the world, and, because it can map a large dynamical domain in a short time, it can handle very small experimental samples.

We would like to build on the success of IN4C by developing the ultimate version of this type of spectrometer that exploits state-of-the-art technology and instrumentation. PANTHER (polarisation analysis on a thermal spectrometer) will do everything that IN4C can do but will do it better. It will have an increased signal-to-noise ratio that will allow smaller samples to be used, and thus open the door to even more complex materials and/or extreme conditions (such as high-pressure studies). This will have the effect of consolidating our user basis in the long-term future.

Magnetism studies, in particular, will benefit from the installation of a large angular bank of position-sensitive detectors (PSDs), including a high-quality small-angle bank that will extend the ILL's capabilities in the thermal range. It will be possible to set and analyse the polarisation of the incident and scattered neutrons respectively. In addition, PANTHER will be able to offer sophisticated sample environments such as magnets and high-pressure apparatus. The spectrometer will be a perfect complement to the ILL's triple-axis spectrometer, IN20.

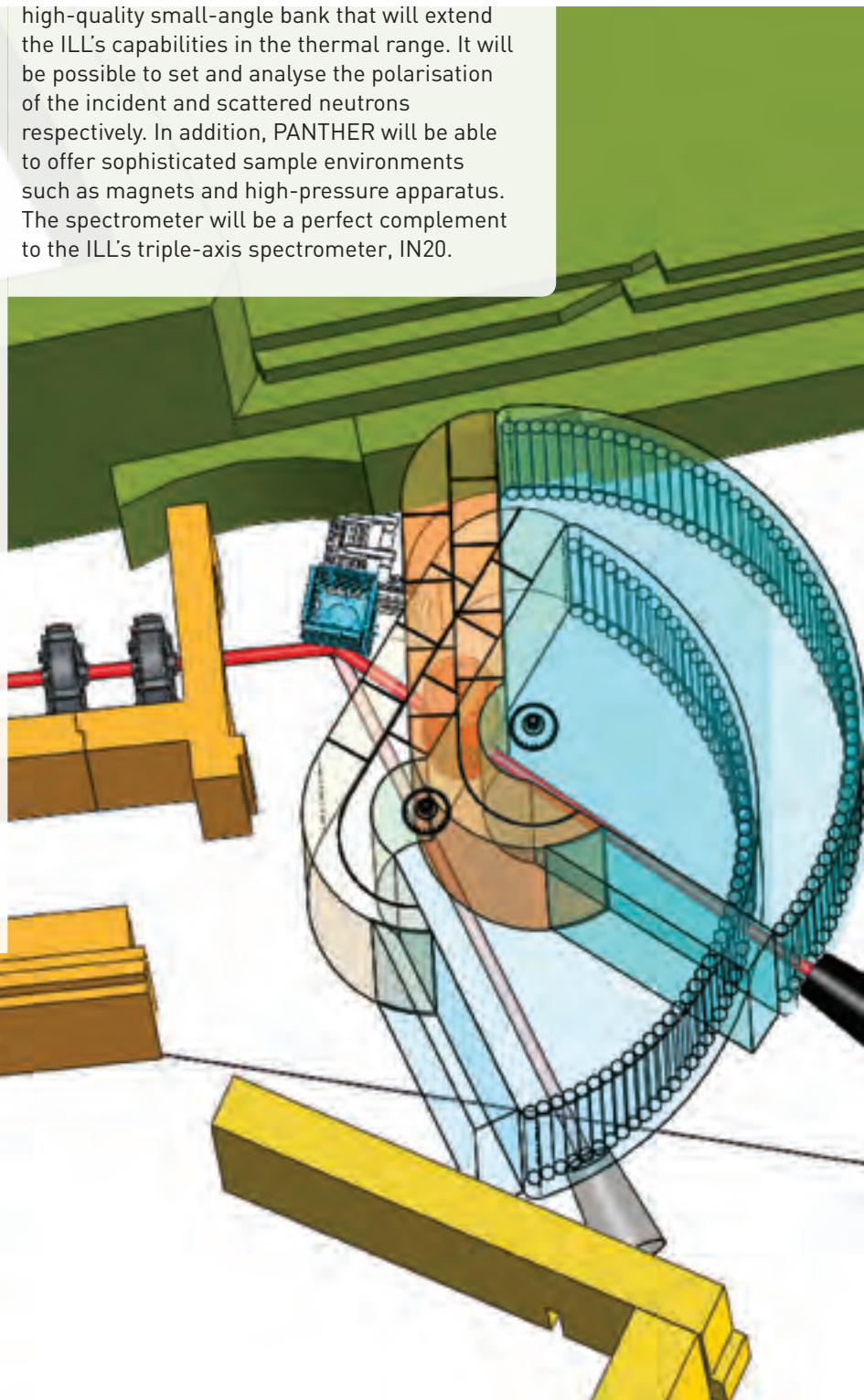

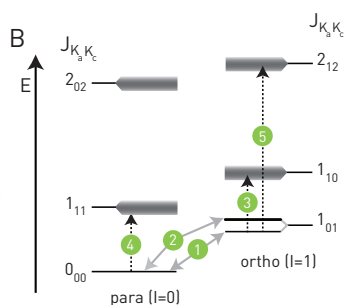

The fine energy spectrum associated with the quantised motion of a water molecule trapped in a fullerene cage
[Horsewill *et al.*, *PRL*, 2009, Beduz *et al.*, *PNAS*, 2012]

SCIENCE SUCCESSES

■ Quantum vibrations in a cage

The quantum levels of small molecules such as hydrogen (H_2) and water encapsulated inside fullerene cages (C_{60} , C_{70}) have been studied on IN4C. The small confines of the carbon cage enable the quantisation effects associated with centre-of-mass displacements of the trapped molecule to be measured, together with the fine structure of the energy spectrum comprising rotation–translation terms.

■ Battery materials and quasicrystals

The high-temperature (800°C) phase of bismuth oxide ($\alpha\text{-Bi}_2\text{O}_3$) is the best oxide ion conductor known, and though not stable at room temperature, it can be stabilised by doping with metal ions such as molybdenum. This compound ($\text{Bi}_{28}\text{Mo}_{10}\text{O}_{69}$) was recently studied using coherent quasielastic scattering and molecular dynamics simulations, and established a link between the ion mobility (oxide-jump diffusion) and dynamical structural disorder. A similar investigation has also shed light onto quasicrystals, intriguing materials with aperiodic crystal structures. The stability of some intermetallic (zinc–scandium) quasicrystals seems to depend on short-range dynamical frustration in the structural ordering.

■ Studies in magnetism and ferroelectricity

In the field of magnetism, recent inelastic scattering experiments combined with theory have shown that the unusual four-sublattice magnetic ground state of silver chromium sulphide (AgCrS_2) can be stabilised through a ferromagnetic first-neighbour exchange along the longest chromium–chromium distance of the monoclinic cell, and a large perpendicular antiferromagnetic second-neighbour exchange. The exchange along the two shortest chromium–chromium distances of the distorted cell remains weakly antiferromagnetic. This shows that, by changing the sign of the first-neighbour interaction, the lattice degree of freedom is the key to the stabilisation of this magnetic structure, providing clues to the possible mechanisms behind ferroelectricity.

FUTURE SCIENCE

■ Studies with polarised neutrons

While the magnetic peaks in the previously mentioned mixed metal sulphide were well separated from the nonmagnetic peaks, this is not usually the case. Polarisation studies would allow us to distinguish the magnetic structure of many more frustrated systems, for example, unusual mixed metal compounds in which the magnetic spins sit in a 2D triangular arrangement called a Kagome lattice. Coupling between nearest neighbours is antiferromagnetic and the geometry results in competing interactions. The spins therefore never settle into a minimum energy state, instead forming a so-called spin liquid, which is of great theoretical interest.

THE UPGRADE

PANTHER will be built at the IN4C's present location, on the thermal beam tube H12. The layout of the instrument is shown on the far left.

- The pre-monochromator will consist of two pairs of fast counter-rotating background choppers and a removable sapphire filter.
- We propose building a new flight box, with cylindrical geometry and a radius of 2.5 m. It will be protected from level C ambience by 30-cm thick boronated polyethylene blocks (on IN4, the thickness is 10 cm). A proper beam-loss tube and beam stop will prevent parasitic reflection from the direct beam, especially at low scattering angles. Vanes made of cadmium will add protection at higher angles.
- The detector bank will consist of PSDs 2 m high, covering a scattering angle from 2° to 132° with minimum gaps between tubes. This will give a solid-angle coverage of 1.61 sr (IN4C covers only 0.6 sr because of large gaps between the tubes).
- When needed, the beam will be polarised using a Heusler monochromator, equivalent to that installed on IN20. Polarisation analysis will be done using helium-3 cells, the x, y, z directions being tuned using a PASTIS insert.

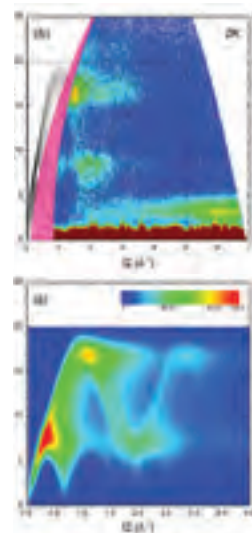

Energy transfer (meV)

Top: the $S(Q,\omega)$ map measured on AgCrS_2 with IN4C. Levels (lines) are derived from the simulation shown in the bottom figure [Damay, *PRB*, 2013]. The cyan dashed line shows the lower limit of the extended dynamical range proposed by the new PANTHER design

PROJECT TEAM:

S. Rols
A. Wildes
S. Fuard
A. Orecchini
O. Meulien
B. Farago

ESTIMATED COST:

EURO 6 million

ESTIMATED PROJECT DURATION:

4 years

D7+ DIFFUSE SCATTERING SPECTROMETER EXPLORING THE QUANTUM LIMITS OF DISORDER

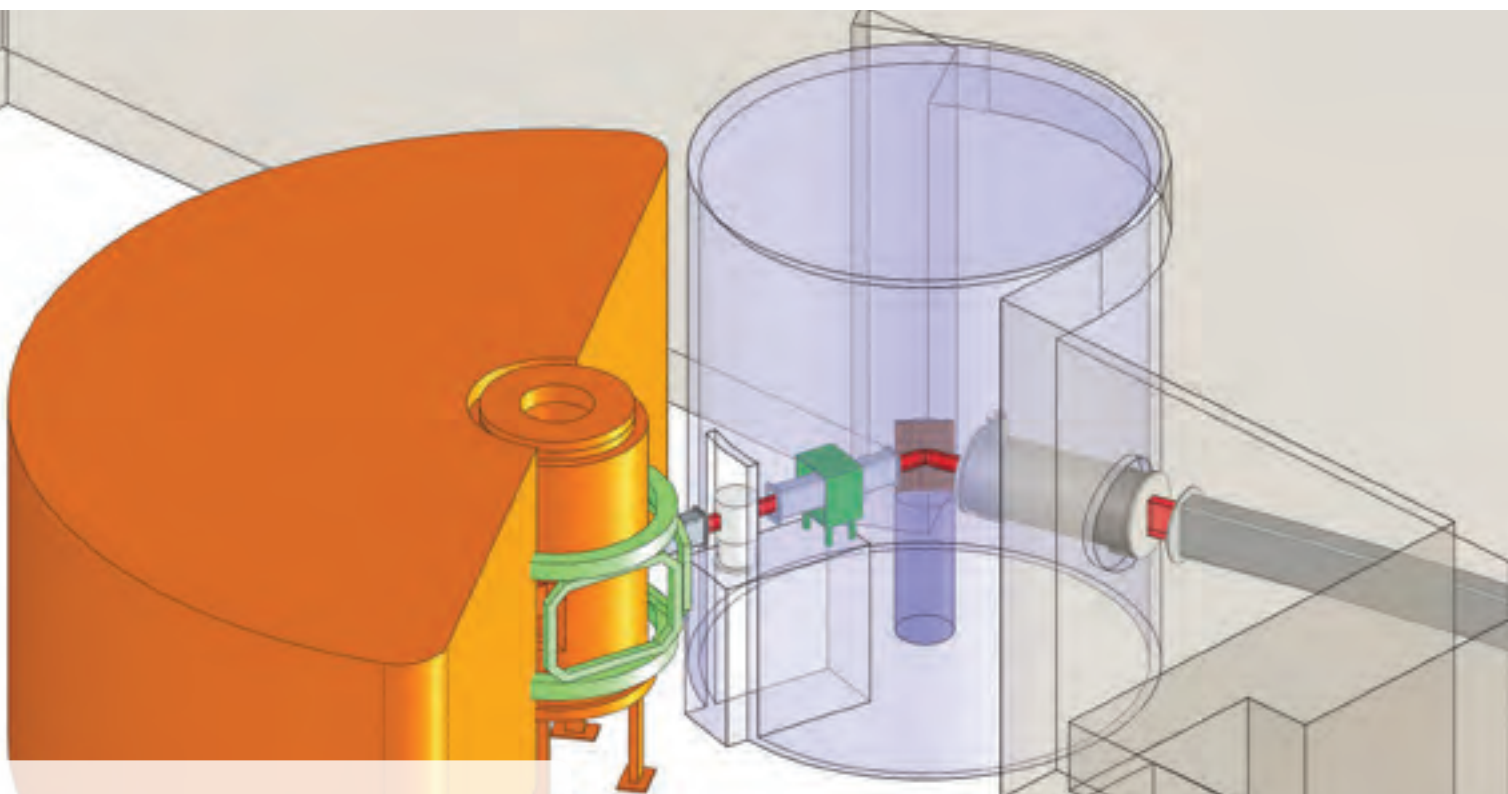

Most neutron scattering studies are carried out on materials with long-range order. The scattering produces sharp, high-intensity peaks – Bragg peaks – at characteristic, discrete scattering angles. However, many interesting materials have randomness inherent in their structures. The most obvious examples are liquids and glasses, but even crystals may contain defects. The atoms of the constituent elements of an alloy may be irregularly distributed in the crystal lattice. In some magnetic materials, the effect of competing interactions between sets of atomic moments can lead to ‘frustration’ of spin orientation, creating a fluctuating magnetic structure.

Such ‘short-range’ order influences many physical properties – compressibility, plasticity, or resistance – as well as leading to fascinating phenomena such as magnetic liquids and glasses, invariance of properties with temperature, quantum entanglement, and analogues for fundamental phenomena such as magnetic monopoles and the Higgs boson.

Short-range order reveals itself as weaker, broader ‘diffuse’ features between the Bragg peaks, and the ILL’s D7 instrument is dedicated to detecting and analysing this scattering. Because the diffuse scattering is broad and relatively featureless, high angular resolution is not needed.



However, diffuse scattering from magnetic behaviour can be masked by that from the nuclear component. D7 therefore uses polarised neutrons to separate out the magnetic scattering, which is then analysed using the ‘xyz’ method (measuring the polarisation in all directions), which was pioneered on the instrument.

D7 went through a major upgrade in the Millennium project, achieving a 25-to-50 times improvement in performance. However, experiments are becoming ever more demanding, and the instrument is once again reaching a performance bottleneck. Smaller samples and those with very small moments are increasingly being brought to D7. Furthermore, although D7 is able to carry out neutron spectroscopy through its time-of-flight option, the instrument is extremely flux-limited in this mode and few experiments are feasible.

Fortunately, the instrument can be upgraded further. Although the secondary spectrometer was upgraded, the primary spectrometer, and particularly the guide, were not. Upgrading them would result in significant flux gains by allowing a more divergent beam to hit the sample.

NEW SCIENCE

■ Experiments on smaller samples with smaller magnetic moments

D7 was recently used to measure the magnetic diffuse scattering from a powdered sample of a mixed holmium germanium oxide, $\text{Ho}_2\text{Ge}_2\text{O}_7$ – a type of frustrated magnetic material known as a spin ice. It is difficult to synthesise, and the weight of the sample was a mere 0.29 g. Fortunately, the holmium moment is large ($10 \mu\text{B}$), so produced a good signal. The scattering revealed the details of the magnetic structure including the emergence of magnetic defects, which are, in effect, magnetic monopoles.

There is now an increasing demand to measure small-moment samples that demonstrate quantum behaviour. When coupled with a small sample mass, the experiments become prohibitively long, if not impossible. A boost in flux by at least a factor of 10 would make these experiments feasible.

■ Experiments on single crystals

Polarisation analysis gives information about the orientation of magnetic moments underlying magnetic behaviour. The results from a single crystal are far less ambiguous than those from a powder, so although D7 was originally built for measuring powders, it is increasingly being used to measure diffuse scattering from single crystals.

A single-crystal experiment on an allotrope of manganese, $\beta\text{-Mn}$, which shows frustrated magnetic behaviour and never orders, revealed the source of the frustration. The crystal was unusually large, though, weighing 17.2 g. D7 needs to be upgraded to enable experiments to be carried out on much smaller crystals.

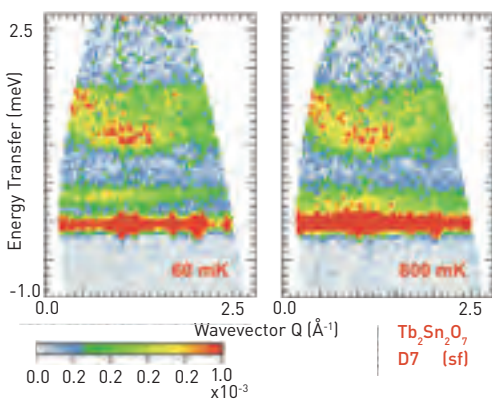

Magnetic spectra from a 35-g powdered sample of $\text{Tb}_2\text{Sn}_2\text{O}_7$, measured on D7

■ Neutron spectroscopy

D7 is currently the only permanently polarised neutron chopper spectrometer in the world. We can measure inelastic scattering, and so can explore dynamics such as the atomic and magnetic vibrations. Their energies tend to overlap, making the data difficult to interpret. However, polarisation analysis clearly separates the scattering.

There is, however, a reduction of the incident neutron flux by a factor of about 150. So far, the results from only one experiment have been published – investigating the magnetic spectrum of terbium tin oxide ($\text{Tb}_2\text{Sn}_2\text{O}_7$). The data are outstanding (bottom left), showing magnetic excitations that explain the magnetic properties of the compound. However, both the sample mass and magnetic moment were very large. Measuring samples with one-tenth of the mass and one-tenth of the moment – without significantly sacrificing the energy resolution – would be possible only if the flux were dramatically increased. The ability to measure dynamics from these samples using polarised neutrons would create enormous opportunities for the ILL and is perhaps the greatest scientific reason for upgrading D7.

THE UPGRADE

Gains of at least a factor of 10 would be possible if the D7 primary spectrometer were rebuilt.

The proposed H14/H15 rebuild in the Endurance project presents an unprecedented opportunity.

The proposed modifications would consist of:

- Substantially increasing the cross-sectional area and beam divergence of the D7 guide.
- Increasing the usable wavelength range to 2–6 Å.
- Polarising the neutrons in the guide.
- Replacing the current triple-blade monochromator with a single, doubly focusing monochromator with a larger area.
- Reducing the monochromator–sample distance.
- Inserting a focusing guide between the monochromator and the sample.

These modifications will substantially increase the incident beam divergence without sacrificing energy resolution. Current estimates predict a gain in neutron flux by a factor of 30 to 50.

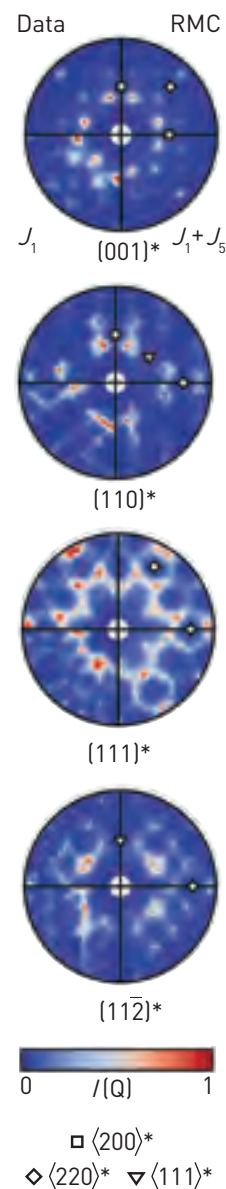

Data from a $\beta\text{-Mn}_{10}\text{Co}_{0.1}$ single crystal, measured on D7, along with calculations for the diffuse scattering [Paddison *et al.*, accepted in PRL]

PROJECT TEAM:

G. Nilsen
A. Wildes

ESTIMATED COST:

EURO 1 million

ESTIMATED

PROJECT DURATION:

1 year

D10+ A FLAGSHIP DIFFRACTOMETER FOR MAGNETISM STUDIES IN VARIOUS CONFIGURATIONS AND EXTREME CONDITIONS

D10 is a triple-axis, four-circle spectrometer that offers a variety of configurations to accommodate a wide range of experiments. It is the only four-circle diffractometer in the world with optional energy analysis. It also provides different sample environments, either in four-circle or normal-beam geometry (with furnaces, pressure cell, magnets and cryostats). Its unique four-circle dilution cryostat allows us to reach temperatures down to 100 mK.

Because of its good momentum resolution, relatively high flux and low intrinsic background, D10

can be used for many kinds of conventional crystallographic studies. In addition, the optional energy analysis enables a restricted energy window to be set, which lowers the background so that delicate problems such as weak diffuse scattering from disordered structures, magnetic multilayers and commensurate-incommensurate phase transitions, can be studied. Inelastic scattering studies, for example of phonon dispersion, can be carried out on large samples in both the four-circle and two-axis modes.

Many different scientific topics that are currently 'hot' can be studied on this versatile instrument. These include not only diffraction studies of conventional crystal structures but also aperiodic crystals and phase transitions in incommensurate systems. The magnetic ground states of frustrated, multiferroic, superconductor, thin-film and multilayer systems can be probed.

The upgrade of the thermal guide, H24, combined with those of both the primary and secondary spectrometers of D10, including an additional polarised neutron option, will increase the flux at the sample position by about 10 times. Such an increase would strengthen D10's position as giving the best Q-space resolution and lowest background in the world, along with the highest magnetic fields, lowest temperatures and highest pressures – thus fulfilling the objective of the Endurance programme.

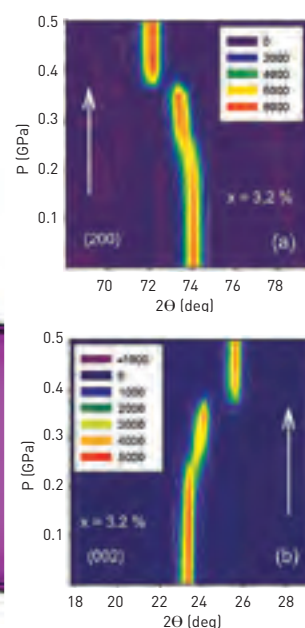

The pressure dependence of the reflections (200) and (002) of $\text{Ca}[\text{Fe}_{0.968}\text{Co}_{0.032}]\text{As}_2$ sample illustrating the appearance of the collapsed phase [K. Prokes *et al.*, *Phys. Rev.*, B85 (2012), 104523]

SCIENCE SUCCESSES

■ Mapping magnetic multilayers

Much experimental work on D10 has concentrated on studying thin magnetic films and multilayers showing giant magnetoresistance, because of their potential technological applications as read-head sensors and magnetic random-access memories. In thin films of, for example, chromium, the role of the chromium layers has recently become the focus of interest, as it appears to mediate the long-range magnetic coupling across the layers. Chromium in the bulk is antiferromagnetic but the periodic ordering of spins in the metal does not coincide with its lattice structure. This incommensurate spin density wave and the antiferromagnetic ordering temperature ($T_N = 311$ K) change in thin films. Diffraction experiments mapped how the modulation and direction of the spin density wave, and the Néel temperature changed with the thickness of the chromium film.

THE UPGRADE

Taking the opportunity of the refurbishment of H24 guide within the Endurance programme, we propose to upgrade completely both the primary and the secondary spectrometers of D10. This upgrade, combined with the replacement of the existing guide by a new optimised supermirror ($m=2$) coating, will lead to an increase of the flux at the sample position by about one order of magnitude, with only a moderate loss in resolution.

The upgrade will also include:

- A polarised neutron option, which would make D10 accessible to CRYOPAD experiments requiring thermal neutrons and high Q-resolution.
- Refurbishment of the radiological protection of the casemate inherent to the renewal of the guide, and the upgrade of the primary and the secondary spectrometers.
- New pyrolytic graphite and copper monochromators with variable vertical curvature, and their mechanics, would be constructed.
- The current sample table would be replaced with a new, non-magnetic one, as well as the analyser.

■ Iron superconductors

Studies of the families of the so-called pnictides, which are based on compounds of iron and arsenic, are another area of intense activity, since they can show superconductivity at relatively high temperatures (up to 26 K). Recently, diffraction experiments were carried out on one pnictide family, $\text{Ca}(\text{Fe}_{1-x}\text{Co}_x)_2\text{As}_2$, investigating the structural changes as the pressure, temperature and composition are altered, and linking them to magnetic and superconducting behaviour (figure centre left). The parent compound, AFe_2As_2 (A is any alkaline-earth metal) is not superconducting at ambient pressure. However, it changes from a tetragonal to an orthorhombic structure below a transition temperature associated with the appearance of antiferromagnetic order related to a strongly reduced iron magnetic moment. These structural and magnetic transitions are gradually suppressed by doping with another magnetic ion – in this case cobalt – or increasing the pressure. At the same time, the onset of superconductivity is observed at a transition temperature as high as 25 K. Furthermore, another tetragonal phase is induced with a further increase in pressure, which has the same geometry but with the much smaller crystal lattice, and is therefore called a collapsed tetragonal phase.

FUTURE SCIENCE

The improvements to D10 will allow it to cover new scientific areas, for example:

- The study of more exotic magnetic systems for which usually only very small crystals (volumes as low as 0.01 mm^3) are available, or which have only a small magnetic moment.
- Thinner-film samples down to only 20-nm thickness.
- Inelastic experiments with three-dimensional access using the four-circle geometry become feasible in an acceptable time.
- Mapping regions of phase diagrams with high magnetic fields (15 T), pressures (100 Kbar) and very low temperatures (20 mK).
- The polarisation option would make D10 accessible to neutron polarimetry requiring thermal neutron and high Q-resolution for a low Q-range.

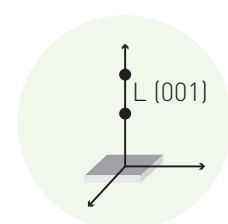
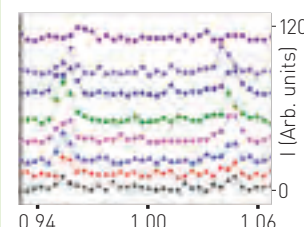
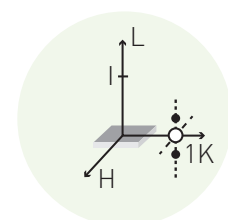
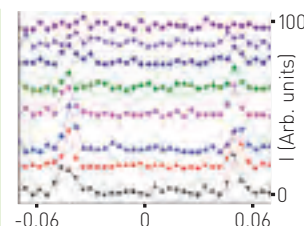

An example of X-ray scattering from a spin wave and magnetic neutron scattering from a strain density wave measured on a chromium/vanadium film of 1000 \AA , which indicates a spin-flip transition from a longitudinal to a transverse spin density wave, both with propagation direction perpendicular to the film plane

[E. Kravtsov *et al.*, *Phys. Rev. B* 76 (2007) 024421]

PROJECT TEAM:

B. Ouladdiaf
M. H. Lemée-Cailleur
J. Allibon
Ph. Decarpentrie
J. Archer
J. Rodriguez Carvajal

ESTIMATED COST:
EURO 0.9 million

ESTIMATED PROJECT DURATION:
2 years

XtremeD

A NEW DIFFRACTOMETER FOR HIGH PRESSURES AND HIGH MAGNETIC FIELDS

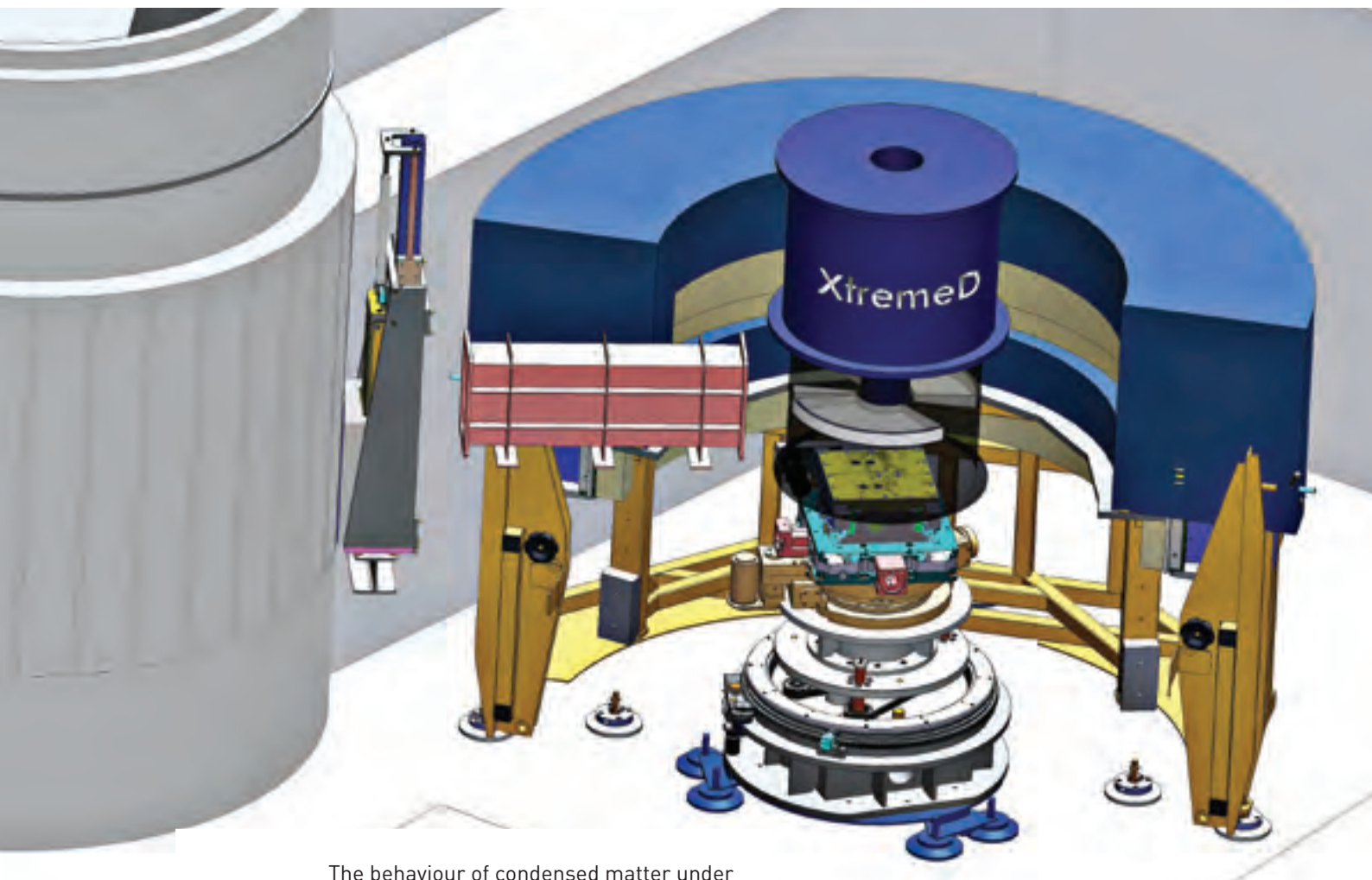

The behaviour of condensed matter under extreme conditions is becoming of increasing significance in many areas of scientific knowledge, and is now one of the priority lines of research worldwide. Neutron diffraction is suited to studies of many materials (particularly those containing light and/or magnetic atoms) under high pressures and in high magnetic fields – and is contributing to progress in developing advanced electronics and magnetic materials, as well as to the geosciences.

To accommodate a growing user community wishing to carry out such experiments, a dedicated extreme-conditions diffractometer, XtremeD, is being constructed at the ILL. One challenge is that high-pressure studies require smaller sample volumes. This makes the focusing optics a crucial part of the instrument in order to obtain the necessary increased flux and to avoid interfering scattering from the sample environment. However, by exploiting new developments in sample environments and beam focusing, XtremeD will be capable of operating at pressures up to 50 GPa, and under magnetic fields up to 15 T, and of being used with both powders and single crystals. The characteristics of XtremeD will make it unique in the world, and should offer a plethora of opportunities for scientific breakthroughs.

The diffraction pattern of hydrated lithium chloride, $\text{LiCl} \cdot 6\text{D}_2\text{O}$ at 4 GPa and 280 K: pressure–temperature path before crystallisation on the phase diagram of pure water; schematic diagrams of ice phases VII and VIII, and view of the Jupiter moon Callisto [S. Klotz et al. *Nat. Mater.*, 2009]

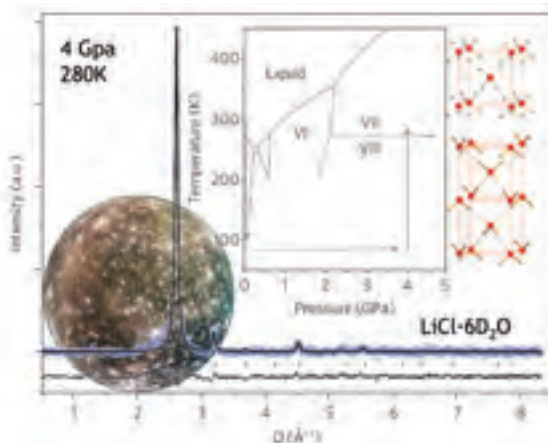

NEW SCIENCE

■ Water-based systems under pressure

The study of ices and other water-based systems under extreme pressures is of great interest for a number of reasons. The many phases of water ice that exist at various pressures provide insights into water's unique hydrogen-bonding properties. These play a crucial role in biological systems, also in the structure of hydrated crystalline compounds and in hydrocarbon clathrates found, for example, in the Earth's polar regions. Planetary bodies also contain ices under high pressures. A recent experiment at the ILL investigated the high-pressure structure of salty ice VII. It was widely thought that ice is unable to incorporate large amounts of salt into its structure, but the neutron experiment demonstrated that substantial quantities of dissolved lithium chloride can be built homogeneously into the crystal lattice of the ice-VII phase. This is of great interest because there is strong evidence of subsurface salty oceans on some of the moons of Jupiter and Saturn in similar pressure conditions.

■ Improved hydrogen-storage materials

Neutron diffraction can contribute decisively to the correct assignment of molecular structure, especially in relation to hydrogen bonding. This was the case with the structure determination of ammonia borane (NH_3BH_3) at high pressure. Furthermore, recent Raman and X-ray studies of this material at high pressure uncovered new solid phases that can store significant amounts of additional molecular hydrogen, increasing by 8 to 12 per cent its already high hydrogen content. Such studies may provide guidance for developing improved hydrogen-storage materials.

■ Magnetism under extreme conditions

The strongest impact of XtremeD will be in the field of exotic magnetic materials with potential technological applications. In recent years, an extraordinary range of compounds, in particular mixed metal oxides, have been prepared that demonstrate intriguing behaviour such as superconductivity and multiferroic properties. Their magnetic behaviour can change drastically under pressure and/or an applied magnetic field. Recently, the complex relational changes in the geometric and magnetic structure of a perovskite, lanthanum chromate (LaCrO_3), were mapped under high pressure at the ILL.

In the future, the capabilities of the new diffractometer will enable crucial contributions to be made in the burgeoning field of iron-based superconductors, helping to resolve the controversy about the coexistence of superconductivity and magnetism in a certain region of the phase diagram.

THE UPGRADE

The main idea of the instrument is to combine a large solid-angle detector with an optionally highly-focused beam on the sample, thus providing high flux while maintaining a low background. XtremeD will be installed at the position currently occupied by IN3 (a triple-axis spectrometer on the thermal side of the ILL7 guide hall, on guide H24), taking advantage of the variable wavelength capacity of its monochromator and casemate and its large experimental zone. A neutron-guide position will also help to provide a low background, which is very important for small samples.

The principal features of XtremeD will be:

- Energy and Q-range: the neutron beam will have a wavelength of between 0.8 and 4.1 Å (optimised at around 2 Å), offering a Q-range of 0.1 to 15.6 Å⁻¹ to cover *d*-spacings of between 0.4 and 47 Å (as required for crystal and magnetic structure determination).
- Extreme conditions: sample environments will offer two configurations:
 - (i) a high-pressure configuration, with the magnetic field limited to 9 to 11 T in order to achieve the maximum pressure of 50 GPa.
 - (ii) a high-magnetic field configuration where the pressure is limited to 5 GPa for reaching the maximum magnetic field of 15 T (17 T without a pressure cell).
- Experimental fields: the instrument will be suited for both powder and single-crystal samples, with a 2D detector offering good resolution in both directions (horizontal and vertical).
- Beam requirements: the use of pressure cells implies that the instrument will have to operate with very small sample sizes (1 mm³) with a very intense and well-collimated beam at the sample in order to keep the background low.

PROJECT TEAM:

J. A. Rodríguez
Velamazán
G. Manzin
P. Noguera
J. Rodríguez Carvajal

ESTIMATED COST:

EURO 3.9 million

ESTIMATED PROJECT DURATION:

4 years

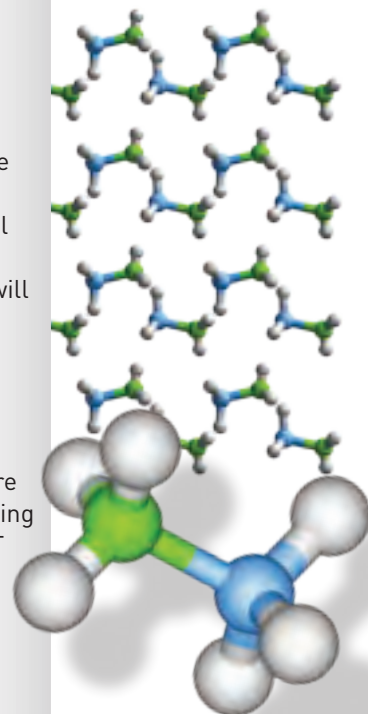

Ammonia borane has been studied as a hydrogen-storage material [Y. Lin *et al.*, *PNAS*, 106, 8113 (2009)]

RAINBOWS -FIGARO

REFRACTIVE ANALYSIS OF INTERFACES
WITH NEUTRON BEAMS OPTIMISED FOR
A WHITE SPECTRUM



Neutron reflectometry is a powerful technique for investigating the structure and composition of surfaces and buried interfaces. It provides information that is inaccessible by any other technique. When combined with selective deuterium substitution and contrast matching, the structure and assembly of thin layers of soft matter such as detergent films and cell membranes can be investigated. The chemical and magnetic behaviour of nano-layers in advanced materials and devices can be also be characterised. Neutron reflectometry thus attracts interest from a wide variety of researchers who are working on key societal issues such as energy, health and the environment, as well as the development of formulations used in everyday products.

Despite the range of scientific findings that have been made, there is still room for improvement. Studies of interfaces are frequently limited by the neutron intensity that can be measured, as it is desirable to measure signals that are perhaps less than one-millionth of the intensity of the incident neutron beam. Also, the amounts of precious samples are often very limited, particularly in areas such as biomedical science. Furthermore, fast kinetic processes in layered structures are frequently left unresolved.

This upgrade involves a new technique for measuring specular neutron reflectivity, which is based on using refraction through a prism to separate and measure wavelengths. Refractive encoding allows the full white beam to be employed without the need for choppers. This means that, depending on the resolution, gains of more than an order of magnitude in flux are possible, opening up a new area of sub-second kinetics in interface research, or allowing very small samples to be studied. The use of the technique is particularly suited to a continuous reactor source. The instrument will be able to measure an intermediate Q-range ($0.01-0.1 \text{ \AA}^{-1}$) faster than a conventional instrument at the future European Spallation Source (ESS).

FIGARO is the most appropriate instrument for this upgrade because it includes the capability to study free liquid surfaces using a vertical scattering geometry. The technical upgrade involves using RAINBOWS with an extended sample-to-detector distance of 5 m and a higher-resolution detector so that the required wavelength resolution can be achieved. The RAINBOWS system would allow a gain in flux of up to 25 times, meaning that reflectivity data could be obtained in 50 ms.

A powerful spinoff of this upgrade would be the enhancement of grazing-angle small-angle neutron scattering (GISANS) performance. GISANS provides a probe for investigating in-plane nanostructure and ordering at interfaces. This upgrade would double the range of lateral length scales accessible by GISANS to 5–400 nm.

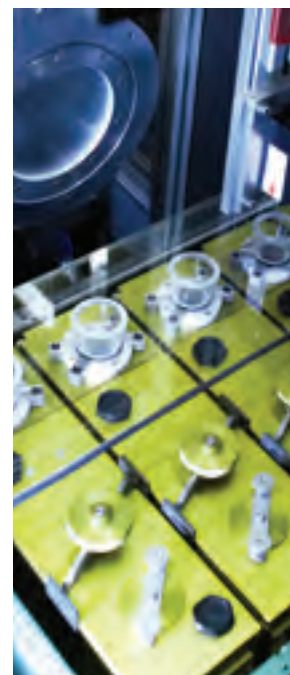

RECENT & FUTURE SCIENCE

■ Understanding ozone poisoning

A research team recently carried out work to understand how pollutants affect the functioning of the human lung. Even small amounts of atmospheric ozone can damage the lung's lipid lining and impair breathing. Using reflectometry, the reaction kinetics of ozone interacting with a model lipid monolayer were monitored in real time using a Langmuir trough (see top-left figure). The RAINBOWS upgrade will allow faster reactions in the domains of biophysics and atmospheric chemistry to be accessed, so that the model formulations studied are closer to those found in the natural world.

■ Hydrogels

Thermo-responsive hydrogels, which are copolymers, can switch between an expanded and a collapsed chain conformation upon a thermal stimulus, and have applications such as nano-switches or drug-delivery agents. The switch involves a large change in the volume occupied by the polymer chains of the copolymer. The swelling and relaxation were tracked *in situ* in hydrogel films, following a sudden temperature jump. The model used in this work was highly dependent on data taken over short periods, which was resolved poorly but will be readily accessible with RAINBOWS.

■ Poloxamers

Poloxamers are copolymers containing a hydrophobic centre and hydrophilic ends. These molecules self-assemble in water to form ordered structures, and have wide commercial applications particularly in the cosmetic and pharmaceutical sectors. Using GISANS on FIGARO, the lateral ordering and packing of these nano-structures were measured at the air-water interface (see top-right figure). Increasing the length-scales accessible to GISANS will allow the study of a broader range of sizes of these particular formulations, as well as a range of other scientific problems such as protein-protein interactions at the surface of lipid membranes.

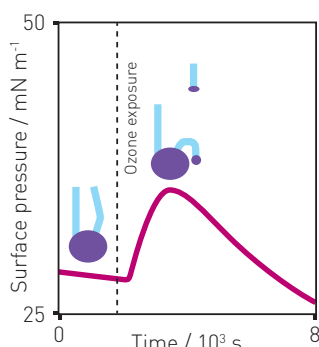

The reaction kinetics of ozone on a lipid monolayer monitored in real time using a Langmuir trough

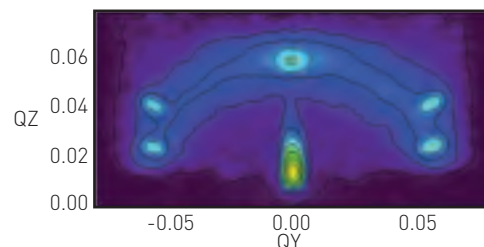

The lateral ordering and packing of poloxamers were measured using FIGARO

THE UPGRADE

■ The bottom-left figure shows the basic principle of refractive encoding. A well-collimated beam passes through a refractive interface, which spreads out the reflected beam at different angles for different wavelengths. The intensity as a function of angle from the reflection is divided by that of the main beam to obtain reflectivity. The bottom-right figure shows the gain as a function of wavelength compared to conventional time-of-flight (TOF).

■ In order to be able to work with free liquid surfaces, FIGARO is the only instrument that can be easily adapted.

■ To achieve a reasonable Q-range in the GISANS mode, and a satisfactory resolution for RAINBOWS, a sample-to-detector distance of 5 m is required, which will be attainable through the moving of the IN5 instrument.

PROJECT TEAM:

E. Watkins
R. Campbell
R. Cubitt
G. Manzin
S. Wood

ESTIMATED COST:

EURO 1.6 million

ESTIMATED PROJECT DURATION:

3 years

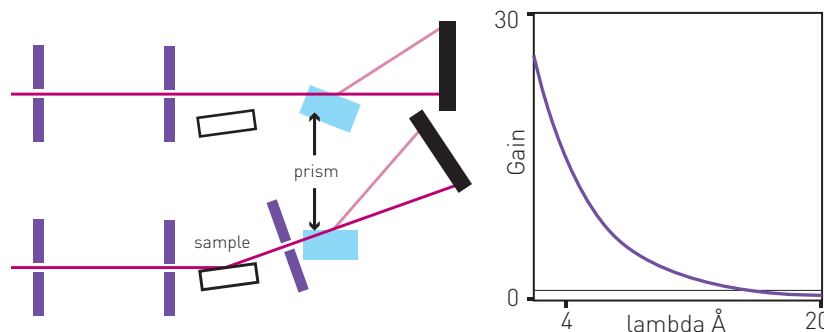

ALADIN

A WORLD-CLASS LAUE DIFFRACTOMETER FOR STRUCTURE EXPLORATION IN COMPLEX MATERIALS

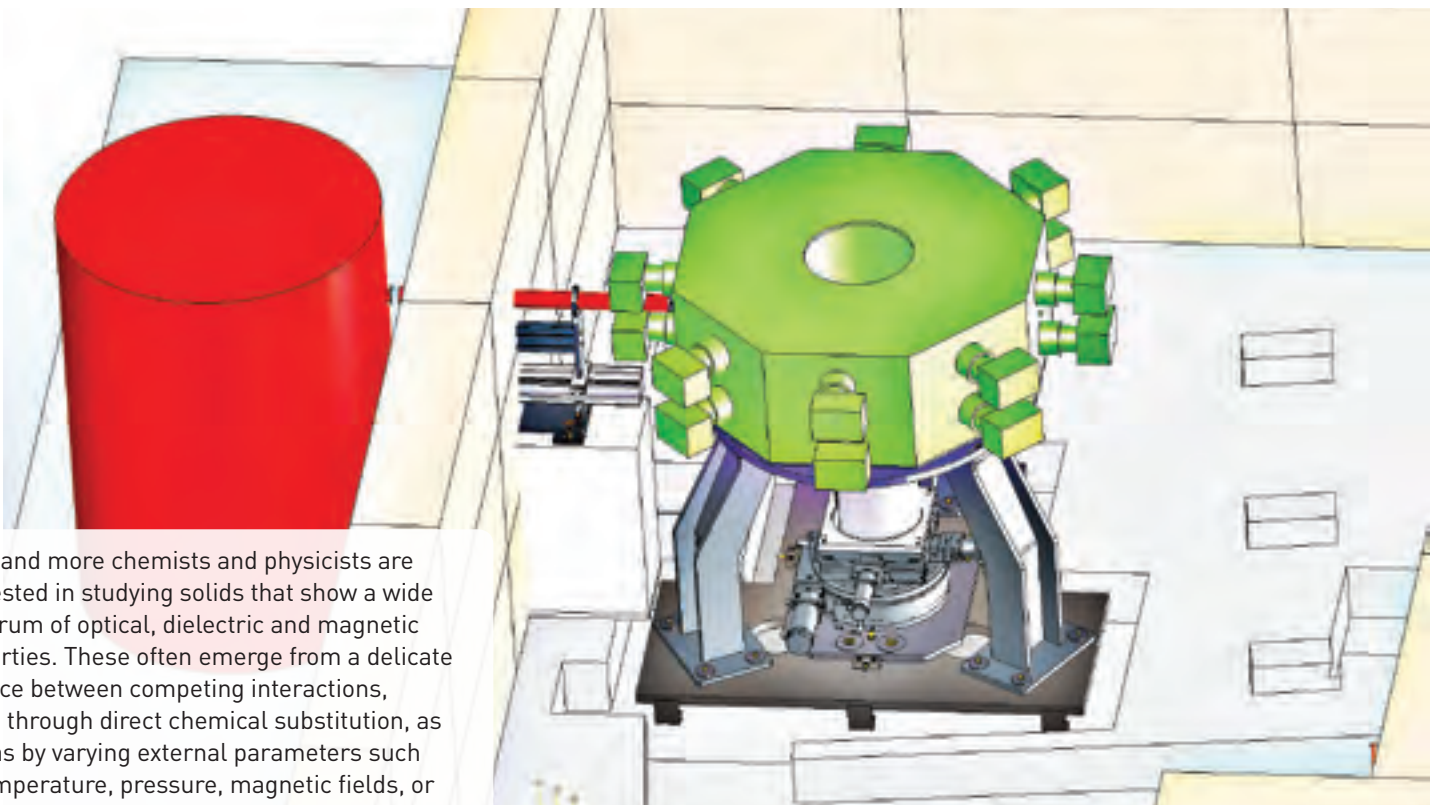

More and more chemists and physicists are interested in studying solids that show a wide spectrum of optical, dielectric and magnetic properties. These often emerge from a delicate balance between competing interactions, tuned through direct chemical substitution, as well as by varying external parameters such as temperature, pressure, magnetic fields, or light. In all cases, a proper interpretation of the experimental results can be performed only with the help of detailed structural studies. However because of their complex nature, these novel materials can rarely be obtained in the form of large single crystals – a situation that somewhat limits the usefulness of neutron diffraction.

With the renaissance of Laue techniques implemented at high-flux thermal neutron sources and the development of CCD-based neutron cameras, structural and/or magnetic information can now be extracted from crystals with volumes of 0.1 mm^3 or smaller, even for supramolecular systems. There is also a possibility of studying kinetics or performing *in-situ* experiments – as is done in the fast data-collection mode on powder-diffraction machines, but with the added capability of visualising structural details afforded only with single-crystal diffraction.

VIVALDI – the ILL's first thermal neutron Laue diffractometer – has clearly demonstrated this potential. However, the data quality suffers from the negative influence of up-stream monochromatic instruments, which makes it difficult to carry out studies requiring a high spatial resolution with very small samples. A recent study conducted on VIVALDI, which is installed on the thermal H22 guide, has

directly demonstrated the dramatic influence of up-stream instruments: flux reduction and considerable perturbation of the incident wavelength distribution, depending on the up-stream monochromator settings (right figure).

An upgraded Laue instrument would need to have a completely clean neutron beam. Therefore – in connection with the Endurance project of renovating the H24/H23 guide – the project, ALADIN (Advanced Laue Diffraction Instrument using Neutrons), will offer an efficient thermal neutron Laue diffractometer constructed at the end of a dedicated thermal neutron guide, decoupled from other instruments up-stream. This will guarantee a smooth incident neutron wavelength distribution, which is essential to obtaining high-quality data with the Laue technique.

ALADIN will then outperform any existing instrument in the world, offering the scientific community the possibility of addressing topical and high-quality structure determinations with sample sizes in the 0.01 mm^3 range (previously accessible only in X-ray diffraction), as well as exploration of kinetics and fast analysis of structure analysis whenever large crystals are available.

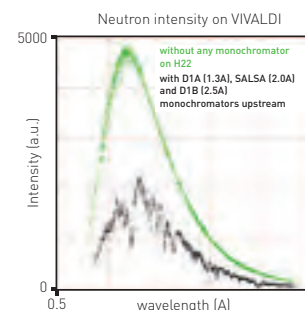

The effect on the wavelength distribution of up-stream monochromatic instruments (VIVALDI@H22guide.ILL)

THE SCIENCE ACHIEVED

■ Molecular multiferroic studies

Multiferroic compounds – in which there is strong coupling between magnetic and ferroelectric behaviour – are currently of great technological interest. Recently, combined Laue and monochromatic diffraction experiments at the ILL unravelled how temperature-related changes in the structure of a mixed-valence iron(II)–iron(III) formate framework could be related to its ferroelectric instability above the temperature of the onset of ferrimagnetic ordering.

■ Solid-state proton migration

Neutron diffraction showed that protons migrate along short hydrogen bonds in dimethylurea–oxalic acid complexes, depending on temperature (far top-right figure). Hydrogen bonding is a weak type of intermolecular binding that plays a significant role in many materials including biomolecules.

■ Porous crystalline organic materials

Neutron diffraction was able to reveal the hydrogen-bonded ring-like structures that are responsible for creating extended flexible pores throughout a simple organic crystal, that of 4-phenoxyphenol. Chemically tailored nanoporous materials are increasingly being used in industry.

THE NEW SCIENCE THAT CAN BE DONE

The new Laue instrument will allow many studies to be carried that were not possible before. Examples are:

- Photo-induced transformations in complex organic solids (multiferroics, molecular magnets) at various pressures and temperatures.
- Hydrogen bonding and polymorphism in agrochemicals.
- The mobility of oxygen ions in solid-oxide fuel cells.
- Bonding in organometallic catalysts.

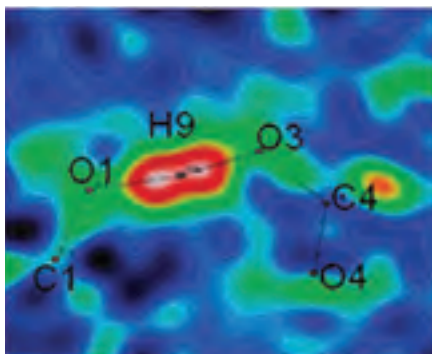
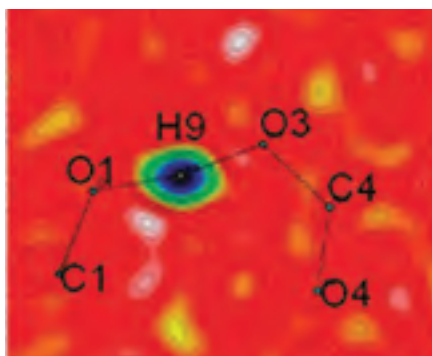

The electronic and nuclear density associated with the H atom in the strong hydrogen bonding in complex, *bis*(*N,N*-dimethylurea) oxalic acid, versus temperature [Jones *et al.*, *Phys. Chem. Chem. Phys.*, 2012, 14, 13273]

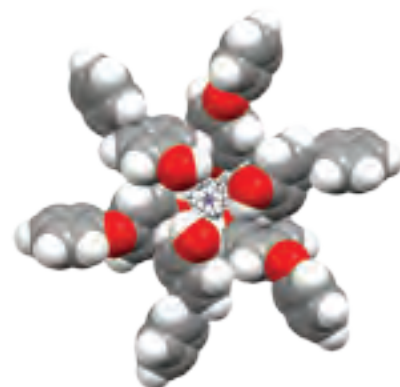

4-Phenoxyphenol: a porous molecular material [Thomas *et al.*, *Cryst. Growth & Design*, 2012, 12,1746]

THE UPGRADE

■ Better location

The siting of ALADIN on a dedicated thermal neutron guide, looking directly at the reactor vessel, is a key point of the project. Location on the H24/H23 guide would be perfect, with a well-adapted beam, a low background and sufficient space for the different instrument configurations as well as for hosting complex sample environments.

■ State-of-the-art detector

ALADIN will benefit from the latest generation of CCD cameras with a wide-bandwidth selector, centred on the region of optimal flux and reflectivity (about 1-2 Å) to limit background.

■ Monochromatic option

A monochromatic option will be installed in case of extreme conditions or kinetics, when cell parameters have to be determined during the Laue experiment.

■ New data-reduction software

In anticipation, we are currently developing a user-friendly Laue data-reduction software, ESMERALDA (for Enforced Software Module for Extended Reading and Analysis of Laue Data), in direct connection with the Fullprof suite already widely used for structural/magnetic analysis.

SCIENTIFIC PROJECT TEAM:

M.H. Lemée-Cailleau
B. Ouladdiaf
J. Allibon
Ph. Decarpentrie
J. Archer
L. Chapon
J. Rodriguez Carvajal

DIFFRACTION GROUP, DIVISION SCIENCE TECHNICAL PROJECT TEAM:

G. Manzin
P. Courtois
SMAE Projects and Division Techniques

COST:

EURO 1.6 million

ESTIMATED

PROJECT DURATION:
3 years

OCTOPUS

A MULTIMODAL DIFFRACTOMETER FOR ADVANCED BIOLOGICAL STUDIES

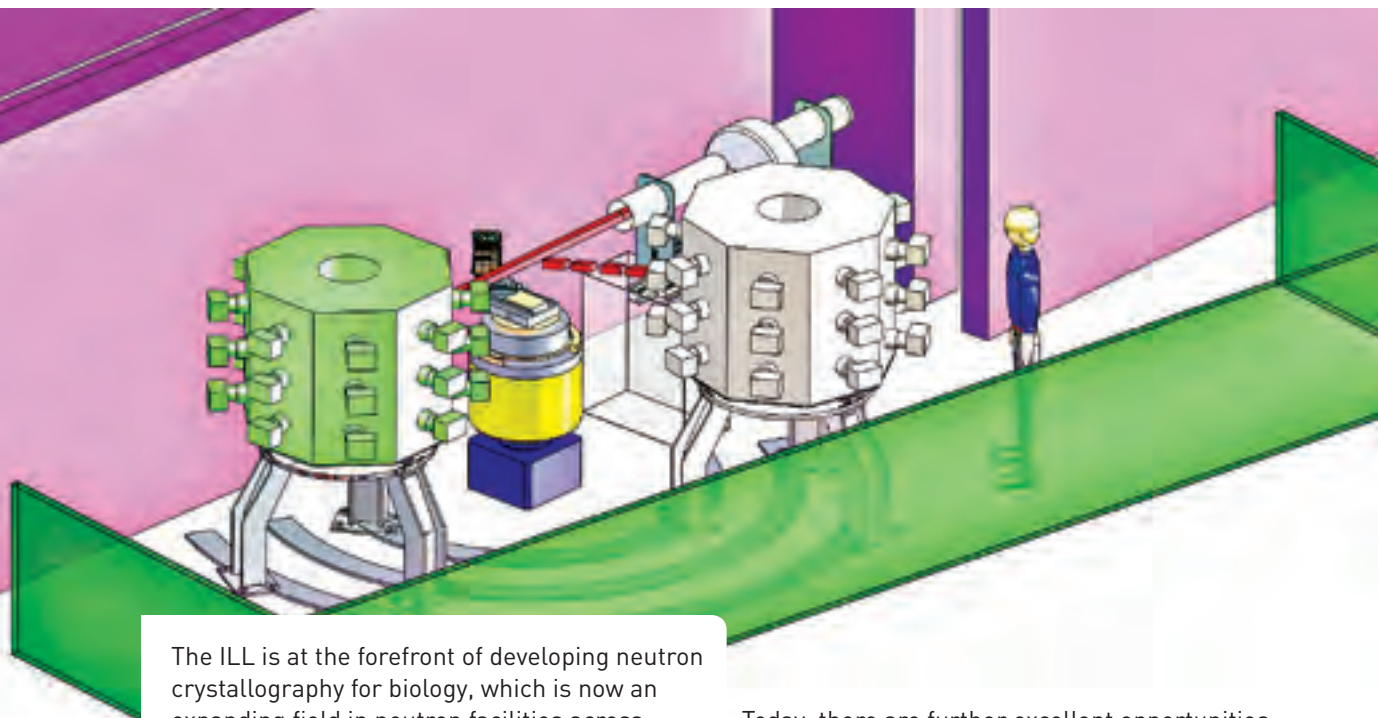

The ILL is at the forefront of developing neutron crystallography for biology, which is now an expanding field in neutron facilities across the world. Neutrons are able to establish the positions of hydrogen atoms in molecular biological systems, not revealed by X-ray crystallography. Information about hydrogen atoms in proteins and lipid membranes, as well as hydrogen bonding and proton transport are essential for an understanding of biological processes and drug design. Furthermore, using deuterium substitution combined with contrast variation, it is possible to map the structural domains of large macromolecular assemblies.

Today, there are further excellent opportunities for improvement in this still young field. LADI-III has been heavily oversubscribed, and D19 is used for a wide range of crystallography studies, with which biological experiments have to compete. With an increasing number of examples of neutron macromolecular studies providing important information that could not be derived from standard X-ray crystallographic methods – and growing interest, particularly from pharmaceutical companies, as well as the personal products and food-supply sectors – the demand for beam time is expected to rise.

The ILL's quasi-Laue neutron diffractometer LADI-III, which incorporates a large cylindrical image-plate detector, is dedicated to biological research, and has had a major impact since its installation in 2007. One of the main issues to overcome has been the small size of biological crystals that can be grown; however, LADI-III has allowed data collection from crystals with volumes as low as 0.05–0.35 mm³ for samples with unit-cell edges from 50–120 Å, respectively. LADI-III is complemented by another diffractometer, D19, which operates with a monochromatic neutron beam and has recently been upgraded to incorporate a large position-sensitive detector. D19 can be used for high-resolution protein crystallography when relatively large single crystals are available. A further important aspect of the success of biological studies at the ILL is its Deuteration Laboratory, which provides fully- or selectively-deuterated samples, as required, on a routine basis.

We are therefore proposing a new instrument dedicated to biological research, OCTOPUS, that will better serve the user community. It would allow more routine and easy access for the increasing number of users, and provide gains of an order of magnitude. OCTOPUS would offer both quasi-Laue and monochromatic modes, so enhancing the ILL's capacity for both high and low-resolution studies. OCTOPUS will also incorporate easily interchangeable sample environment options (cryo-stream, humidity stream) and provide *in-situ* spectroscopic options such as Raman spectroscopy. Such an instrument would thus maintain the ILL at its forefront position in the field of macromolecular crystallography.

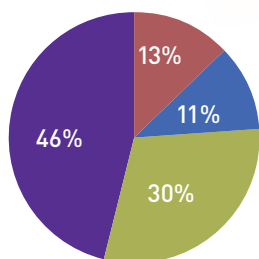

Macromolecular neutron structures deposited in the Protein Data Bank, ordered according to their release date

SCIENCE SUCCESSES**■ Neutrons help find improved HIV drugs**

HIV-1 protease is currently one of the most studied proteins because it plays a key role in the life-cycle of the HIV virus. Inhibitors that bind strongly to the enzyme are an important target for rational drug design. A recent study on LADI-III of HIV-1 protease bound to the inhibitor, amprenavir, uncovered significant new information about the binding interactions – not seen with X-rays. It showed that only two strong hydrogen bonds were involved in the interaction between the drug molecule and the enzyme's active site, instead of multiple hydrogen bonding as inferred from the X-ray data.

■ Insights into energy processes in bacteria

D19 has illustrated the potential for near-atomic-resolution monochromatic data collection in studies of the bacterial protein rubredoxin. This small iron-sulphur protein is responsible for electron transfer and thus metabolism in sulphur-eating bacteria and Archaea. The results showed, for the first time, that there were protonated water molecules, hydronium (H_3O^+) ions, embedded in the protein's structure, which clearly play a part in the electron-transfer process.

NEW SCIENCE**■ Uncovering reaction mechanisms**

OCTOPUS will enable much smaller crystals and bigger biological systems to be investigated in more detail, for example, small drug molecules bound in large macromolecular complexes and proteins embedded in lipid membranes. With the cryostream option, intermediate states in biological catalytic reactions could be studied so that the reaction mechanism could be determined, while the humidity-stream option allows contrast-variation studies with varying degrees of deuteration to be carried out on a single sample.

■ Signal transduction

The complex and large G protein-coupled receptors involved in signal transduction controlling cellular responses (research that won the Chemistry Nobel Prize in 2012) are examples of systems that could be studied with neutrons. They are involved in many diseases, and are the target of nearly half of all modern drugs.

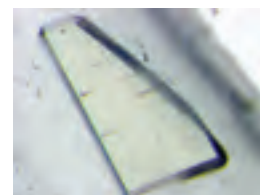

A crystal of HIV-1 protease, Neutron studies reveal the details of the hydrogen bonding

PROJECT TEAM:

M. P. Blakeley
S. C. M. Teixeira
C. Mounier
R. Cubitt
M. Kreuz
B. Giroud
E. Mitchell
S. McSweeney
V. T. Forsyth

ESTIMATED COST:

EURO 2.2 million

ESTIMATED PROJECT DURATION:

3 years

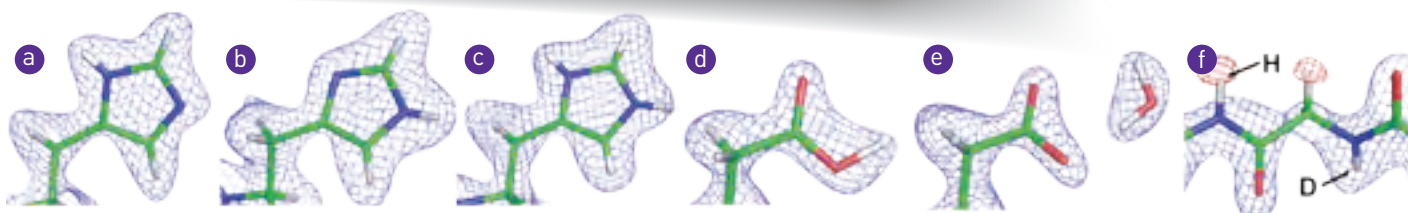
**THE UPGRADE**

■ In the quasi-Laue mode, the neutron wavelength range will be selected from various multilayer filters located in the carousel, and the beam will then pass into the octagonal CCD/scintillator detector array with the crystal located at the centre. Typically, a wavelength range of 3.0–4.1 Å is selected, though for larger unit-cell systems, a narrower range may be chosen to avoid spatial overlaps, and/or to shift to longer wavelengths so as to improve the reflection intensities. For smaller unit-cell systems, the wavelength range is widened to increase data collection efficiency, and/or shifted to shorter wavelengths to collect higher resolution data.

■ For the monochromatic mode, a selected monochromator is moved into the beam path and the detector moved to the required take-off angle. When a small unit-cell system diffracts to atomic-resolution, the monochromatic option at a wavelength of 2.4 Å can be used to collect to even higher resolution than in quasi-Laue mode. For low-resolution contrast-variation studies, a wavelength of 7.5 Å would be used.

Examples of information provided using neutron diffraction data at high resolution: (a - c) the three possible protonation states for a histidine residue; (d) a protonated glutamic-acid residue; (e) a charged glutamate residue hydrogen-bonded to a deuterated water molecule (D_2O); (f) adjacent backbone amide groups from a D_2O -exchanged crystal. To the left, the hydrogen remains un-exchanged, while to the right the hydrogen has been exchanged for deuterium

SuperSALSA

STRESS AND IMAGING
ANALYSIS FOR MATERIALS
SCIENCE AND ENGINEERING

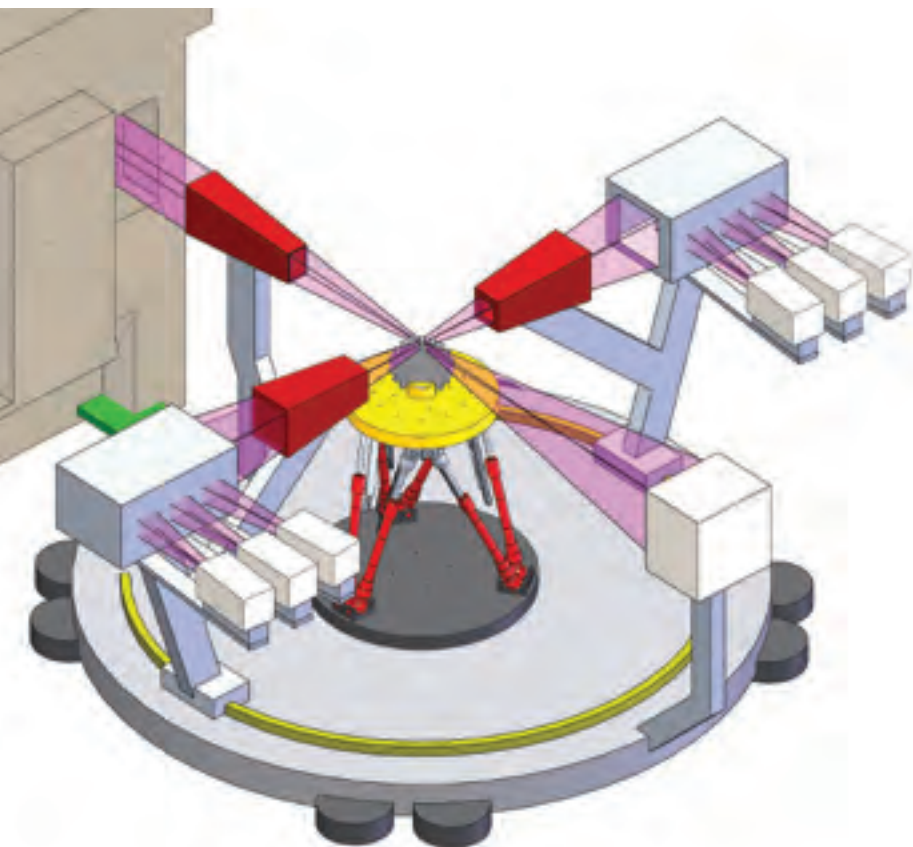

Although SALSA's performance is outstanding in terms of acquisition rate, precision, lateral resolution and flexibility of sample manipulation, stress is only one parameter in the suite of materials characterisation demanded by materials scientists. They may need to analyse the textures and phases, and the distribution of elements, in an object at a given stage in its manufacture – and *in situ*.

The proposed new instrument, SuperSALSA, will add these capabilities to the current instrument, by offering a white beam option, which will allow textures and phases within the sample to be analysed. By placing the sample in the white beam and analysing the scattered intensity using two large crystal analyser units, selected parts of the diffractogram will be recorded within acquisition times of around 1 s.

Imaging techniques will also be possible for a small additional cost. Using the 2D SALSA detector, in combination with a double copper monochromator, will allow Bragg-edge imaging for fast strain and texture mapping, and element-specific imaging with improved contrast. By installing germanium detectors, prompt gamma neutron activation analysis (PGNAA) will be possible, so that spatially-resolved elemental analysis can be performed.

The white beam option will share SALSA's guide, beam optics and sample stage, so will be efficient in terms of cost and use of resources. The monochromatic option will be retained, since it will remain advantageous for pure engineering applications.

The proposed instrument furnishes new opportunities not only for materials scientists and engineers, but also for other user groups – until now not strongly represented – such as geologists and archaeologists who also may need to analyse complex, bulky samples non-destructively.



An as-cast aluminium billet for stress determination on SALSA

High-performance products are developed through close collaboration between materials scientists and engineers. This is particularly true in the transport and energy sectors, where reliability and safety, efficiency, durability and environmental sustainability are important design criteria. Every step of fabrication, from casting the raw material, through various processes such as forging and welding, to final construction, needs to be optimised. This requires a large palette of analysis and characterisation techniques. Often non-destructive methods are required – and, since many processes cannot be downscaled to laboratory dimensions, realistically-scaled components need to be examined.

For the past eight years, the ILL has operated a dedicated diffractometer, SALSA (Stress Analyser for Large Scaled engineering Applications), which measures residual stresses in materials and components by mapping interatomic distances. It has successfully demonstrated the importance of this non-destructive method in optimising process parameters and bonding techniques, and validating engineering models.

A SCIENCE SUCCESS

■ Aluminium alloys for aeronautics

The process of casting introduces stresses into a metal, which causes defects such as cracks, distortions and hot tearing that can lead to premature failure. Crack formation in large billets poses serious safety concerns, and usually results in the rejection of the cast parts. It is therefore necessary to study the internal stresses that develop during processing, so as to minimise their effects by controlling the production parameters.

The size and the distribution of residual stresses in industrial size, as-cast aluminium alloy billets, were prepared with different casting speeds, and measured on SALSA (bottom right figure). The influence of the casting speed on residual stresses and on the stored elastic energy was assessed, and the measured stresses were used to validate numerical models. However, measurements were performed on the final material only. To understand and predict the formation of internal stresses, it is essential to know how and when these stresses start to build up during solidification. This investigation has recently been performed on SALSA. The high neutron flux allowed the solidification process to be followed, by observing the formation and shift of the aluminium diffraction peak during the casting of aluminium-copper alloys.

FUTURE SCIENCE

■ Structure and composition measured *in situ*

The properties of an alloy also depend strongly on its detailed structure and composition – the formation of intermetallic phases, gradients in composition, segregation and precipitation. These parameters determine the strength and fatigue life of a final component such as an airplane fuselage. The white beam option of SuperSALSA will overcome these limitations and allow for *in-situ* studies, for example, during solidification and subsequent cooling.

A unique property of neutron imaging techniques is the extremely high contrast to hydrogen. Using the imaging unit on SuperSALSA, Geologists will have a powerful tool for studying the water intake in rocks in real time, which is vital information for studying erosion processes.

In a similar way as for materials scientists, archaeologists will be able to take advantage of the combination of diffraction and imaging tools on SuperSALSA. Strain and texture maps, together with chemical compositional gradients, could help to uncover ancient manufacturing methods, and use of tools and weapons – and even help in the reconstruction of ancient battles.

PROJECT TEAM:

T. Pirling
Z. Szaraz
B. Giroud
S. Martinez
J. Allibon
P. Courtois
B. Guerard

ESTIMATED COST:

EURO 2.5 million

ESTIMATED PROJECT DURATION:

3 years

THE UPGRADE

■ The white beam option of SuperSALSA will be installed at the same guide as SALSA, sharing the hexapod sample stage and beam optics components.

■ For white beam diffraction, two multi-analyser/detector units will be positioned symmetrically with respect to the sample, and will record two stress components and changes in composition simultaneously in a well-defined gauge volume. It will use a focusing guide, plus radial collimators for gauge volume definition.

There will be two imaging options:

(i) Option 1 will use SALSA's 2D detector, plus a double monochromator, for spatially resolved Bragg-edge imaging, and for strain and texture analysis or element-specific radiography/tomography.

(ii) Option 2 will use a high-resolution scintillator/CCD detector for radiography/tomography.

(iii) For PGNA, position-sensitive germanium detectors at the same location as the multianalyser arrays will enable spatially-resolved element analysis to be carried out.

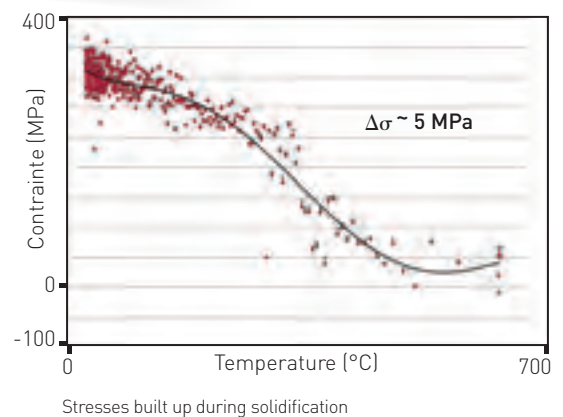

exTAS

A NEXT-GENERATION TRIPLE-AXIS SPECTROMETER FOR MILLIMETRE-SIZED SAMPLES

Highly correlated electron systems, often with unusual magnetic structures, are the focus of investigations employing a range of experimental techniques because of their theoretical significance and their potential technological applications. These systems include, for example, the copper-oxide based high-temperature superconductors, already being technologically exploited, as well as various families of one or two-dimensional magnets in which chains or planes of magnetic moments may demonstrate interesting phenomena such as frustration and quantum entanglement.

Neutron inelastic scattering provides an ideal tool for studying spin behaviour and relating it to crystal structure, together with the low-energy quantum excitations typical of these systems. However, there is a drawback that has hampered neutron experiments in these emerging fields: the required single-crystal samples often cannot be grown large enough to reach volumes of 0.1 to 1 cm³, currently considered as standard for neutron inelastic scattering. Even if large single crystals can be grown, their synthesis introduces significant delays before neutron spectroscopy experiments can be performed.

Furthermore, there is an increasing interest in studying these systems under extreme conditions. For example, even a tiny reduction of interatomic distances in the overall crystal structure, brought about by applying high pressure, can cause dramatic changes in magnetic behaviour, which then provide insight into exchange interactions and the quantum behaviour of the electron spins. However, increasing pressure means working with smaller samples. Pressure cells can accommodate volumes of only about 20 mm³, which are then compressed to even smaller volumes.

The ILL is therefore looking to demonstrate a concept for a new triple-axis spectrometer, exTAS, that would allow samples of just a few cubic millimetres volume to be studied. The main obstacle to overcome is that the neutron flux density itself cannot be increased beyond the limits already achieved in the current instruments. The only gain margins that are left consist in relaxing the instrument resolution to the lowest acceptable limits, to obtain more luminosity, and in maximising the signal-to-noise ratio in the measured signal.

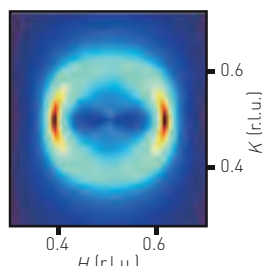
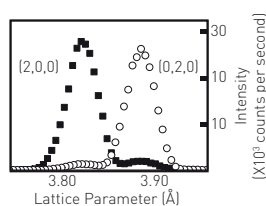
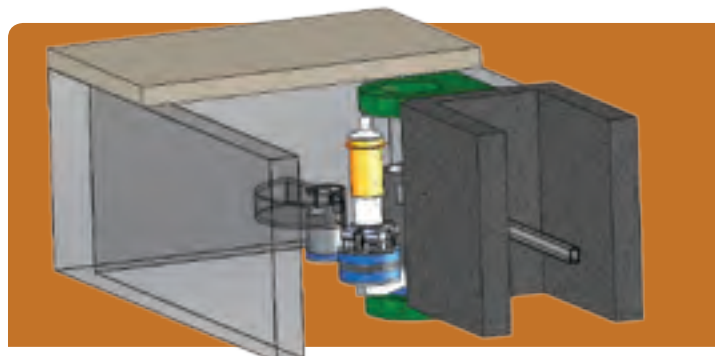

The neutron scattering response of high-temperature yttrium barium copper oxide [V. Hinkov *et al.*, *Nature*, 430 (2004) 650]

The essential idea of exTAS is therefore to reduce the total number of neutrons incident on the sample area to the strict minimum contributing to the measured signal, and to avoid unnecessary illumination of the sample environment. Precise focusing with a flexible beam divergence would provide the maximum possible sample illumination with an optimum momentum and energy resolution. For this reason, a cold (warmish) neutron source will be the best choice for exTAS, as it will match the most interesting energy range and provide a scope for gains in luminosity by relaxing the momentum resolution to values similar to those of a thermal-source instrument.



SCIENCE SUCCESSSES AND FUTURE CHALLENGES

■ High-temperature superconductivity

Studies of the mechanism underlying high-temperature superconductivity in the cuprates has been an ongoing field of research for more than 25 years. However, it is still extremely difficult to grow large perfect single crystals of even the best-known member of the cuprate family, yttrium barium copper oxide ($\text{YBa}_2\text{Cu}_3\text{O}_{7-x}$); they always emerge twinned so that they appear to be tetragonal instead of orthorhombic as they truly are. This masks the anisotropic features of the compound's true scattering response. It has been only recently that sufficiently large assemblies of tiny de-twinned crystals have been prepared for neutron spectroscopy experiments, which have uncovered the true anisotropic nature of the two-dimensional spin fluctuations that appear to play a significant part in the superconductivity mechanism.

Similarly, in many other cases, the crystal volumes of 50 mm^3 represent a real maximum limit, and neutron investigations have to be carried out with this constraint, resulting in extended data-acquisition periods, reduced signal-to-noise ratio and in the difficulties in carrying out polarised neutron work.

■ One-dimensional quantum magnets

Compounds consisting of magnetically interacting chains of atoms provide a test-bed for investigations of a variety of quantum phenomena including magnetic frustration and quantum entanglement. For example, the chain compound, lithium copper vanadate (LiCuVO_4), provides a model of a frustrated system in which the ferromagnetic exchange between nearest neighbour copper atoms is not as strong as the antiferromagnetic exchange between second nearest neighbours, resulting in two uneven sets of competing interactions. Recently, the resulting entangled spin dynamics were successfully explored in experiments at the ILL. They revealed the pattern of continuous spin flipping as two sets of broad energy signals, one of which could be distinguished from the background only because of an excellent signal-to-noise ratio.

■ Quantum spin systems under pressure

A new frustrated two-dimensional magnet is currently creating interest. Strontium copper borate, $\text{SrCu}_2(\text{BO}_3)_2$, contains neighbouring spin-coupled pairs of copper oxide (CuO_4) flat rectangular units. The pairs sit orthogonally to each other to create an unusual spin superstructure. Researchers are interested in studying the quantum spin dynamics of this model system under pressure using neutron spectroscopy, which would be facilitated by the availability of a suitably designed instrument.

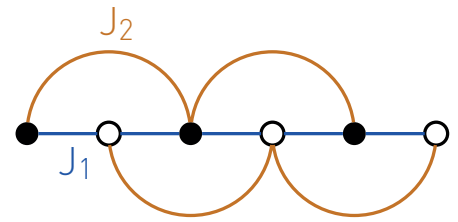

The scattering response of a frustrated ferromagnetic spin-1/2 chain system, lithium copper vanadate [M. Enderle *et al.*, *Phys. Rev. Lett.*, 104 (2010) 237207]

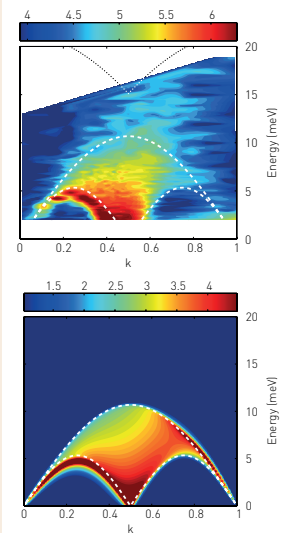

PROJECT TEAM:

A. Piovano
J. Kulda
S. Roux
P. Courtois

ESTIMATED COST:

EURO 1.7 million

ESTIMATED PROJECT DURATION:

3 years

THE UPGRADE

- The required goals can be achieved with a compact exTAS setup placed at an end position on a high-flux sub-thermal guide filtered by a velocity selector.
- A high-precision input slit (virtual source) will be placed at the entrance of a compact, completely shielded hutch with a footprint of about $3 \times 3 \text{ m}^2$, housing the monochromator, sample and the secondary spectrometer.
- The monochromators and analysers will use bent perfect crystals, at present mainly silicon, but potentially also germanium and diamond, capable of producing sharp, mm-sized focal spots.

- The compact layout will enable the momentum resolution to be relaxed beyond the presently accepted limits, by changing the lateral width of the irradiated monochromator/analyser surface, affording a possible gain of an order of magnitude in luminosity.
- A multiplexed secondary spectrometer (FlatCone type) and polarisation-analysis equipment are considered as optional equipment.

NESSE

NEW STANDARDS
FOR SAMPLE
ENVIRONMENT

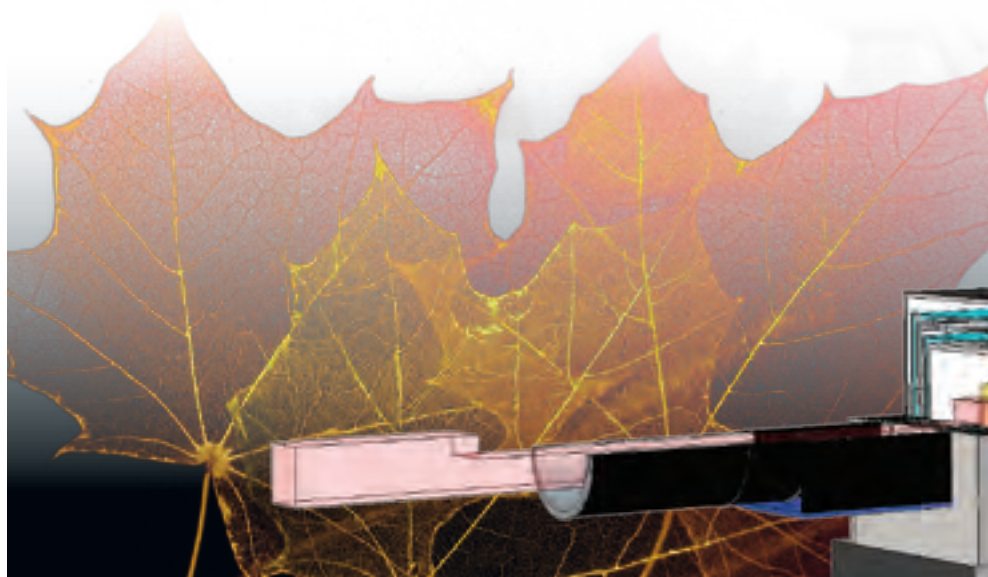

The NESSE project aims to provide and maintain the best experimental capabilities for the ILL's suite of world-leading instruments.

GAS SORPTION ANALYSIS

Designer porous materials that readily take up gases are key to many modern technologies such as industrial catalysis, pollution control and hydrogen storage. We now have available two new volumetric gas sorption analysers that will allow users to control and measure the stepwise absorption and desorption of minute quantities of gases in samples.

■ A recent science success: metal-organic frameworks

Mesoporous metal-organic frameworks (MOFs) have great potential as catalysts, and as separation or storage materials for light hydrocarbons and hydrogen. Quasi-elastic neutron scattering experiments carried out with the new volumetric gas sorption analyser allowed us to measure the diffusion of methane in two MOFs, MIL-47(V) and MIL-53(Cr).

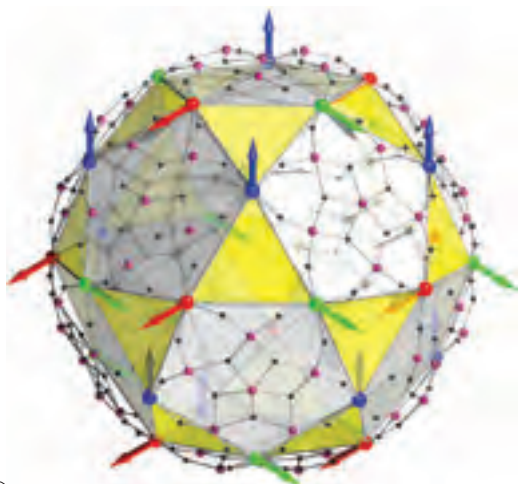

LEVITATION TECHNIQUES

When conducting high-temperature experiments on liquid samples, it is difficult to prevent them from becoming contaminated by container materials. The problem can be overcome by employing levitation techniques that allow the free flotation of the sample. We have developed a new aerodynamic system, which uses up to four orthogonally positioned gas jets to hold a sample in place, while it is heated with lasers. This approach is extremely flexible; it can be used in experiments examining the performance of optical fibres and storage devices, new metallurgical processes, nuclear waste storage, the inner cores of planets, and the single-droplet drying of proteins and peptides for deep-lung delivery.

■ A recent science success: yttria-alumina melts

Liquid phases with identical composition but different structures and thermodynamic characteristics may explain the anomalous properties of a wide range of materials, for example, water. Recently, X-ray scattering experiments on supercooled suspended drops of yttria-alumina melts indicated that there was a metastable liquid-liquid phase transition at 1788 K. However, small angle neutron scattering experiments found no sign of the transition. The debate continues.

A ball-and-stick representation of the $(\text{Mo}_{72}\text{Fe}_{30})$ molecule

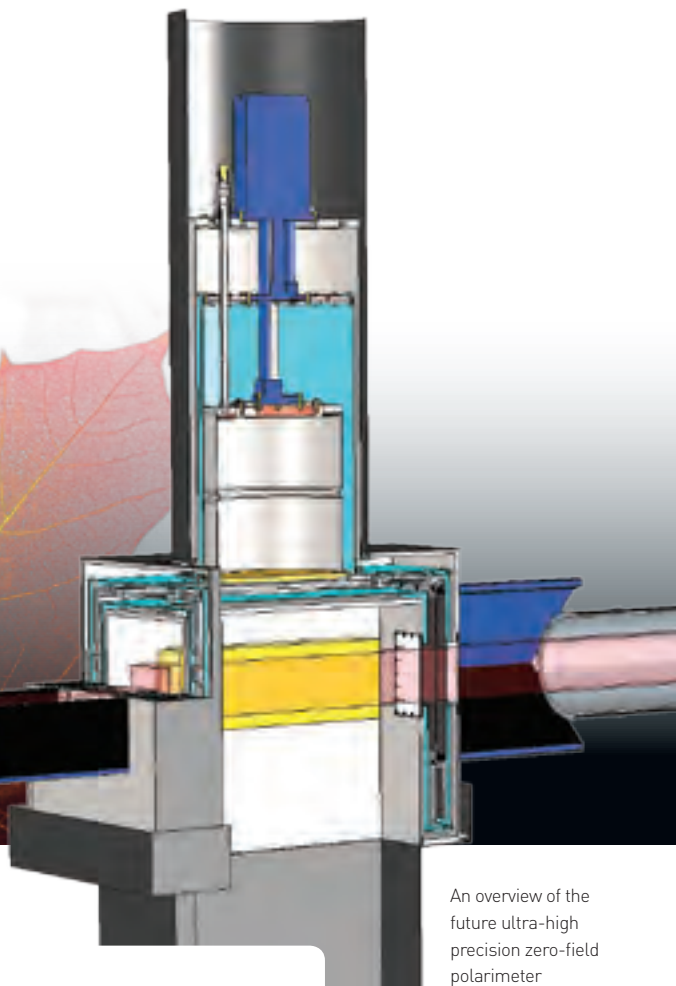

An overview of the future ultra-high precision zero-field polarimeter

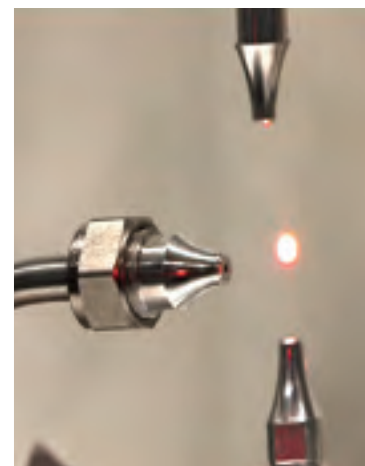

The aerodynamic levitation of stainless steel heated with a $10\ \mu\text{m}$ laser beam

HIGH PRESSURES

The behaviour of materials under high pressures is of increasing interest, particularly in relation to elucidating subtle bonding and quantum phenomena at very low temperatures. The insights gained are also important in developing new materials and understanding planetary processes. Materials studied under pressure vary from minerals and metallic compounds to water and simple elements like hydrogen. The ILL now has a unique 20-GPa Paris-Edinburgh press accommodated in a cryostat, which can cool such samples to 3 K.

■ A recent science success: solid oxygen

Even substances of astrophysical and geological significance, like molecular oxygen, have not been extensively explored at high pressures and low temperatures. Recently, experiments using the new press led to the discovery of three different antiferromagnetic structures of solid oxygen (O₂, the only elemental molecule carrying an electronic magnetic moment).

TECHNIQUES FOR SOFT-MATTER RESEARCH

Experimental support for kinetic and other *in-situ* measurements required by the soft-matter community is to improve. New-generation humidity chambers, stopped-flow systems, rheometers, electric-field cells and adsorption troughs will be developed, and complementary techniques such as static/dynamic light scattering, ellipsometry and calorimetry will be implemented.

In addition, the new technology of microfluidics will allow us to address needs for the rapid mixing of very small amounts of fluids in controlled conditions and measuring their properties in the neutron beam. The equipment will contain a large surface area or capillary network in which moving materials can be followed.

■ A future experiment: magnetic nanoparticles

There is great interest in using magnetic nanoparticles in medicine, for cell labelling, imaging and tracking, and as carriers. Tumours can be targeted with magnetite nanoparticles, which then selectively kill the cancer cells when localised heating is generated by an applied magnetic field. An experiment using microfluidics could simulate the processes involved.

HIGH MAGNETIC FIELDS

In studies of advanced electronic and magnetic materials, the application of a magnetic field dramatically influences properties, making it an important experimental parameter. To date, our community has extensively used diffraction and triple-axis spectrometry to study field-dependent phenomena. However, the lack of supporting infrastructure for SANS and time-of-flight instruments, and high magnetic fields (maximum 15 T), prevents our community from tackling fundamental scientific problems. The production of high-temperature superconducting magnets has made significant progress, and will afford an opportunity to reach much higher fields (up to 25 T) for a reasonable investment and low operation cost.

■ A future experiment: molecular magnets

Molecular magnets are used to develop and explore concepts of quantum magnetism in a simple environment with a small number of interacting spins, which are then probed with neutron scattering. The possible quantum configurations, which are uncovered by applying a magnetic field, could be studied in much more detail by increasing the field strength currently available.

NEW EQUIPMENT TO PROBE THE FUNDAMENTALS OF NATURE

The ILL leads the way in experiments attempting to measure the electric dipole moment of the neutron (nEDM). If it were discovered, then it would provide crucial evidence for fundamental theories of particle interactions and the evolution of the Universe. The current experiment relies on examining the resonant behaviour of ultra-cold neutrons in electric and magnetic fields. However, there is another approach that measures the rotation of neutron spin when neutrons interact in a non-centrosymmetric crystal. The principle has already been demonstrated at the ILL, but the experiment itself would require dedicated equipment.

■ A future experiment measuring the neutron electric dipole moment

A totally new nEDM experiment will be set up with a device that incorporates larger quartz crystals, suitable neutron beam characteristics and better polarisation analysis.

PROJECT TEAM:

E. Lelièvre-Berna
S. Baudoin
N. Belkhier
E. Bourgeat-Lami
J. Gonthier
J.-P. Gonzales
J.-L. Laborier
O. Losserand
F. Marchal
P. Martin
Y. Memphis
P. Mendes
C. Payre
X. Tonon
S. Turc

The 20 GPa Paris-Edinburgh VX5 press



BASTILLE

A REVOLUTION FOR DATA TREATMENT AT THE ILL

The instrument upgrades encompassing the Endurance programme will significantly increase neutron count rates obtained in experiments, resulting in greater amounts of data to process into scientific results. It is vital, therefore, that the ILL provides state-of-the-art, versatile software that maximises the planned efficiency gains right across the instrument suite. This software must also be easy to use and intelligent – particularly to

reduced data, corrected of artefacts, for users. Furthermore, specialised analytical software was often developed by individuals throughout the research community. An important challenge, therefore, is to bring together a heterogeneous set of both established and new tools so that it can be developed and maintained as a coherent whole. It must also be coupled to the ILL's unique instrument-control software, NOMAD.

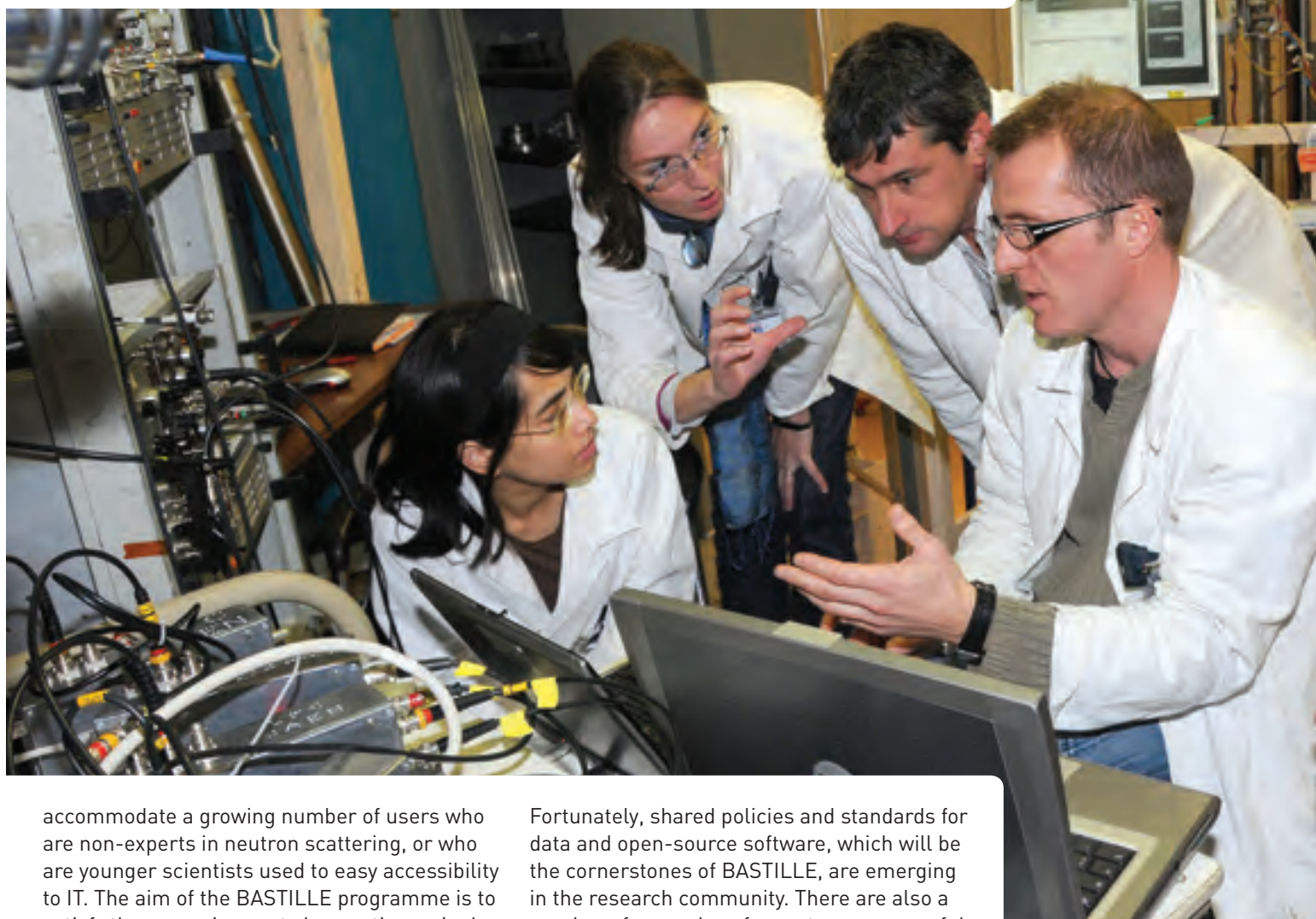

accommodate a growing number of users who are non-experts in neutron scattering, or who are younger scientists used to easy accessibility to IT. The aim of the BASTILLE programme is to satisfy these requirements by creating a single, coherent software infrastructure at the ILL to enable both occasional and experienced neutron scattering users to achieve the optimum outcome for their experiments.

DATA-ANALYSIS TOOLS AVAILABLE NOW

In the first decades of neutron-scattering experiments at the ILL, most users were experts and could treat their own data. Typically, the instrument scientists developed their own software for specific instruments, producing

Fortunately, shared policies and standards for data and open-source software, which will be the cornerstones of BASTILLE, are emerging in the research community. There are also a number of examples of easy-to-use, powerful codes, in some cases, already coupled to instrument control (for example, LAMP, GRASP and RESTRAX) that constitute a basis of knowledge and methods to be integrated in BASTILLE. In addition, the ISIS neutron facility in the UK has recently undertaken a major project developing data-treatment software called MANTID, which is currently being evaluated at the ILL.

BASTILLE will be a key part of an integrated system that produces scientific results in the most efficient way. Clearly identified, maintained and developed software will help to create a traceable data lifecycle – from experiment proposal to scientific output. The project will be managed by the Computing for Science group with the support of the Instrument Control and IT groups.

FUTURE SCIENCE ADVANTAGES

■ Routine measurements

Unlike the automated work-flow infrastructure set up at synchrotron sources essentially to deal with the huge demand for routine protein X-ray crystallography, no neutron scattering instrument is dedicated to single repetitive tasks. However, there are routine measurements made on almost all instruments, where data acquisition and treatment could follow the protein crystallography approach, while still providing opportunities to intervene at each step in the workflow if needed. This would leave scientists with more time and effort available for the novel, cutting-edge experiments.

■ Non-expert and industrial users

A growing number of new, non-expert users, who also include those from industry, will be able to obtain meaningful scientific results – not just data – in a seamless, intelligent way.

■ Instrument scientists and expert users

Instrument scientists and expert users will also benefit from being able to do the simple things more easily. Further efficiency gains will be possible, as software will be provided to minimise the time spent on collecting data that is not useful (for example, in a spectroscopy measurement when the temperature is too low to give a measurable peak broadening).



Spreadsheet for reducing small angle scattering data to S(Q)

THE UPGRADE

- For data analysis, we will identify the key codes, and work with developers of established packages to improve them and integrate them in the data-treatment workflow, or otherwise integrate data analysis directly with software for data reduction.
- The software infrastructure will use, as far as possible, standard libraries available in the open-source community. A high-level computing language such as Python will make the software accessible to expert scientists for further development and customised applications.
- Low level, high-performance code in the software kernel (for example, in C++), will be needed to treat the larger datasets produced by some instruments, and also the higher data rates from new instruments designed to accommodate *in-situ*, time-resolved measurements in which each neutron is recorded individually.
- The software will be usable in command-line mode for experts and interaction with NOMAD. All routines for users will generate their own interfaces, exposing the functionality and necessary parameters.
- High-level graphical user-interfaces will provide streamlined access to data reduction and analysis for non-expert users. The software will be highly modular, using and evolving with modern information technology in terms of not only hardware and languages but also ergonomics and working practices (for example, cloud computing and tactile screens), which will be adapted to meet the expectations of new, young and occasional users.
- BASTILLE will enable interaction with software tools for modelling instruments and samples, which are becoming essential for analysing data, and also with the instrument-control software (NOMAD) to allow on-line data reduction and analysis.

PROJECT TEAM:

Computing for Science Group

ESTIMATED COST:

EURO 2.2 million

ESTIMATED

PROJECT DURATION:

4 years

'Time-dependent scattering functions resulting from the spreadsheet analysis'

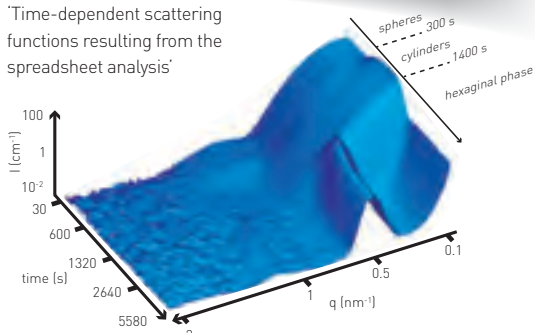



NEUTRONS FOR SCIENCE

INSTITUT LAUE-LANGEVIN

6 rue Jules Horowitz
BP 156
F-38042 Grenoble Cedex 9
France
web: www.ill.eu

October 2013

Published by the Communication Unit
Institut Laue-Langevin
Email: communication@ill.eu