

MILLENNIUM PROGRAMME: 2000 - 2018

The Millennium Programme delivered a large number of projects as shown below, with WASP currently being finished. This investment is essential to increase capability in order to address new scientific and societal challenges, and maintain our scientific output - bottom figure. (Note that the minimum in publication output was due to the renewal of the reactor vessel).

FORWARD

Over the last decades neutron scattering in Europe has seen a big step forward both in capacity and capability. Apart from new sources, progress has been primarily fuelled by technological improvements in neutron delivery and neutron detection combined with computer aided instrument optimization. At the ILL this process has led to a series of ambitious upgrades managed under the Millennium and Endurance Programmes. The Millennium M-0 phase has seen 14 projects completed by 2009 while the M-1 phase is entering its final stage with the commissioning of WASP in 2018. In total, the Millennium program saw 26 new or upgraded instruments with a financial volume (exclusive of in-house staff costs) of ~80 M€ over a period of 15 years i.e. ~5 M€/year. The return on this modest investment is never the less impressive and as a result the ILL can offer state-of-the-art experimental facilities to the users. The constant high demand for beam time and concomitant high-quality publication output demonstrates the attractiveness of services provided.

Modernisation of the ILL instrument suite and support infrastructure continues under the Endurance programme. It will be a considerable project challenge to make this 60 M€ investment in 8 years i.e. 7-8 M€/year while continuing to ensure a high level of availability of the scientific infrastructure at ILL.

This short brochure gives a brief overview of the Endurance programme at the time of the ILL-ESS User Meeting in October 2018. It collects together the posters prepared for the meeting, which describe the projects in more detail. We hope that you will be able to discuss the projects during the User Meeting and that this document will serve as a reference as the projects are delivered in the coming years.

And for the future, all new ideas for instrumentation, sample environment, data treatment, etc are welcome – please share them with us...

Charles Dewhurst - Endurance Coordinator - and the ILL directors

Millennium Programme - instruments and budgets

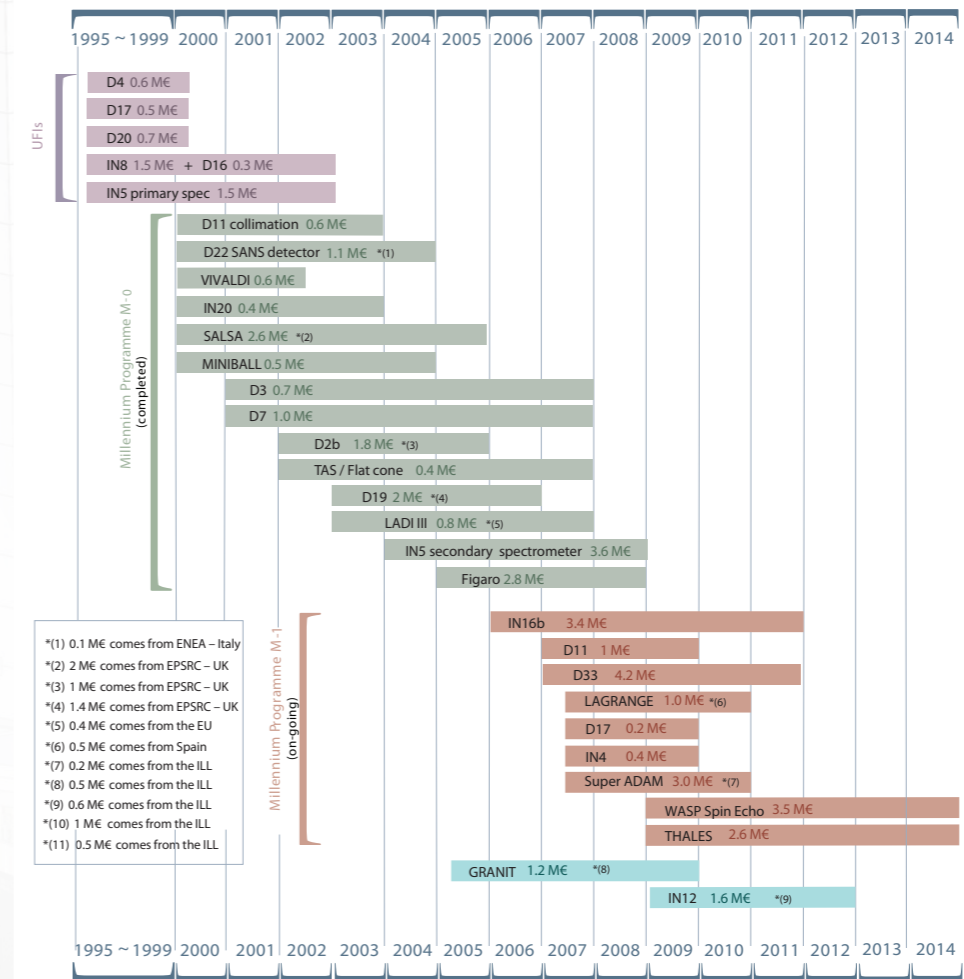

Publication output

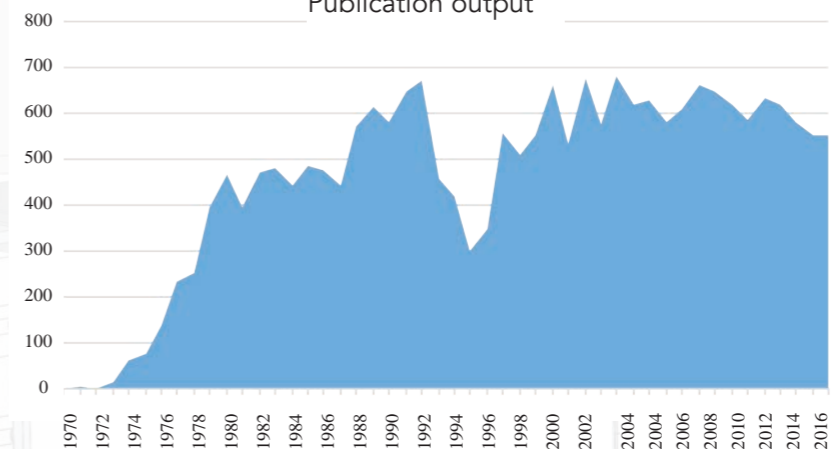

MILLENNIUM PROGRAMME: WASP

WASP, the Wide Angle Spin Echo spectrometer, is the last Millennium project. As these photos show, installation is almost complete and commissioning can start soon.

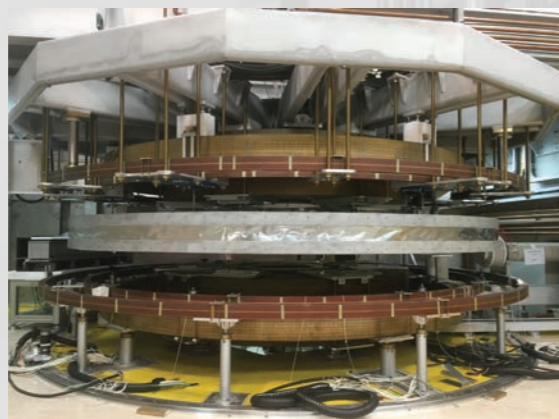

ENDURANCE PHASE 1: 2016 - 2020

The original Endurance project was split in two phases. Phase 1 includes the projects listed below, with a focus on renewing the guide system H24 and its instruments. The budget of Endurance-1 is 22 M€. Additional 'CPER' funding of 4.3 M€ from the French state, region and city has enabled this part of the programme to be extended.

PROJET	DESCRIPTION	DELIVERY
FIPPS	New fission product γ -ray spectrometer	2016
FIPPS	Anti-Compton detectors	2018
RAINBOWS	White-beam reflectometer option	2017 (Proof of principle)
D17	Guide & chopper upgrade	2018
PANTHER	Thermal neutron chopper spectrometer	2019
H16/IN5	Guide and beam focusing optics	2019
SUPERSUN	Next-generation ultra-cold neutron source	2019
D3 liquids	Wide angle detector & polarization analysis	2019
H24	Thermal neutron guide renewal	2020
D10 ⁺	Single cristal diffractometer	2020
IN13 ⁺	Backscattering spectrometer (CRG)	2020
XtremeD	New extreme condition powder & single crystal diffractometer	2020
H1-H2	Beam tube renewal	2020
IN20	Velocity selector	2020
NESSE	Sample environment equipment	2016 - 2019
BASTILLE	Data treatment software	2016 - 2019

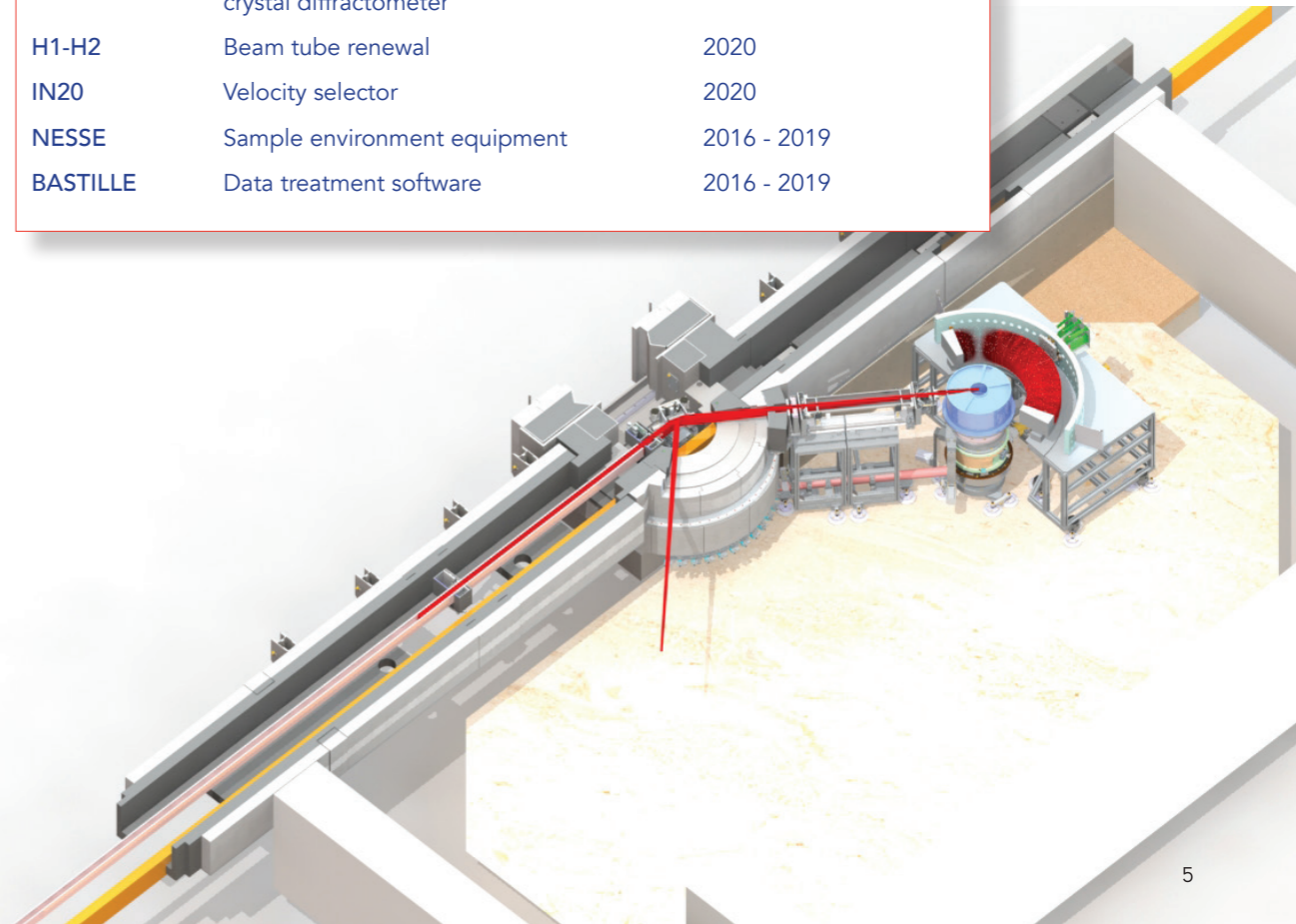

ENDURANCE PHASE 1: FIPPS

GAMMA-RAY SPECTROMETER FOR THERMAL NEUTRON INDUCED NUCLEAR REACTIONS

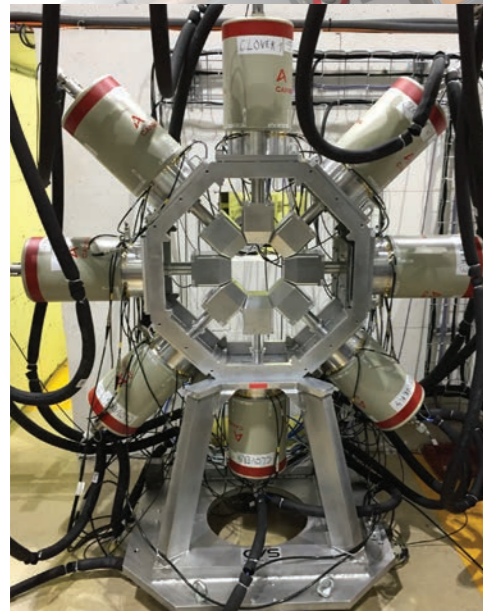

ENDURANCE PHASE 1: PANTHER

A THERMAL NEUTRON, TIME-OF-FLIGHT SPECTROMETER, REPLACING IN4

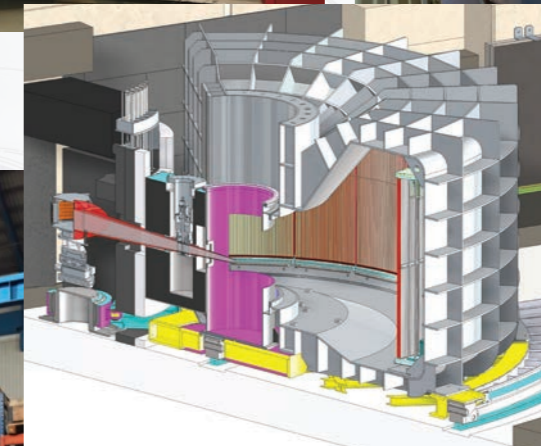
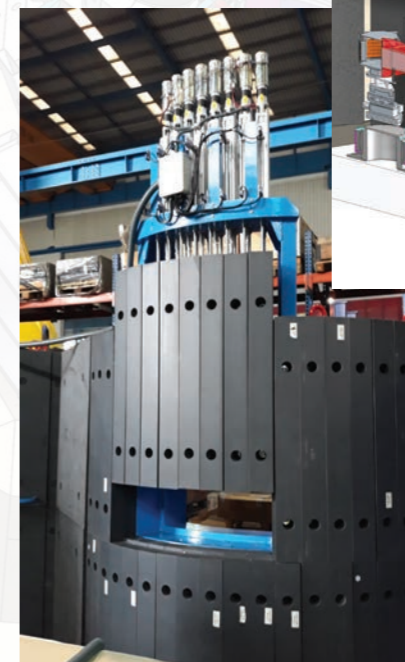

ENDURANCE PHASE 1: H24

NEW THERMAL GUIDE, A NEW POWDER AND SINGLE-CRYSTAL DIFFRACTOMETER – XTREMED – AND UPGRADED INSTRUMENTS – D10+ AND IN13+

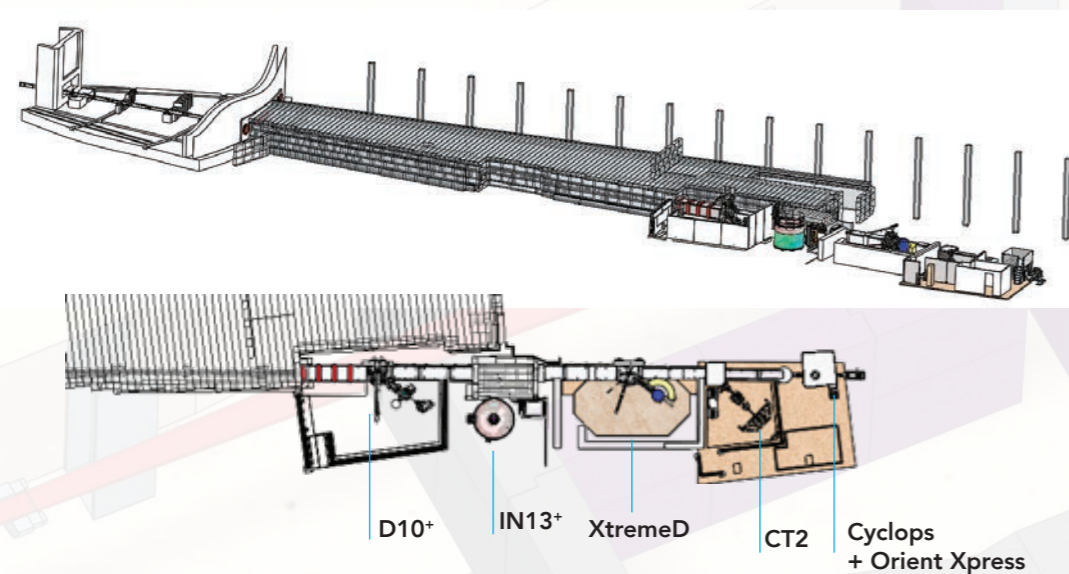
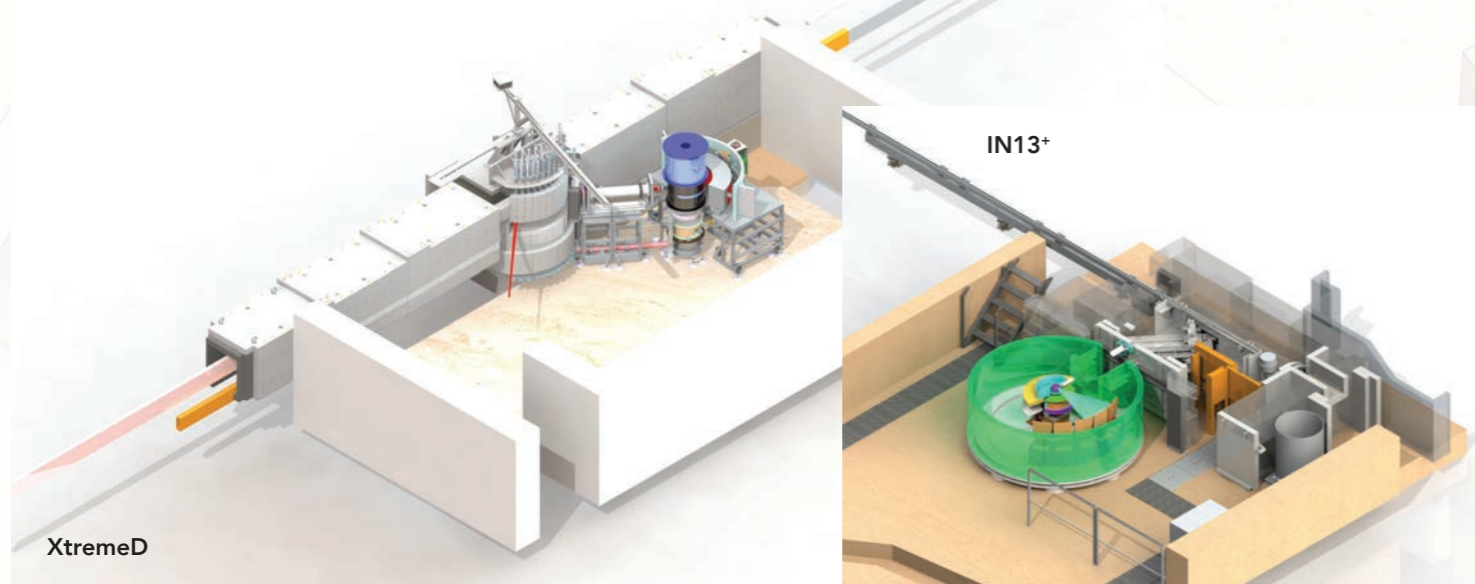

ENDURANCE PHASE 2: 2019

Endurance-2 projects were initiated with an open call at the start of 2017 and approximately 40 were received for a total budget of 60 M€. Following careful evaluation by the Instrument Sub-committee, the Scientific Council and the Steering Committee, two-thirds of the projects were retained for a budget of approximately 40 M€. This set of projects has been split into three parts, the first to be started in 2019 as detailed below.

PROJET	DESCRIPTION	DELIVERY
D11	Large area detector	2021
D22++	Wide angle detector	2021
D16	Wide angle detector	2021
D20c	Replacement detector	2021
IN20	Monochromator and multianalyser/detector	2021
LADI-B	Second protein crystallography station	2019
IM2020 -NeXT	Public imaging beam line	2020
H15	Guide design	2019
NESSE2	Sample environment equipment	2019 - 2023
BASTILLE2	Data treatment software	2019 - 2023

ENDURANCE PHASE 2: 2019 - DETECTORS

The photos below show 2 detectors developed in Endurance Phase 1. In Phase 2 there will be major detector projects on D11, D22, D16, D20 and D19.

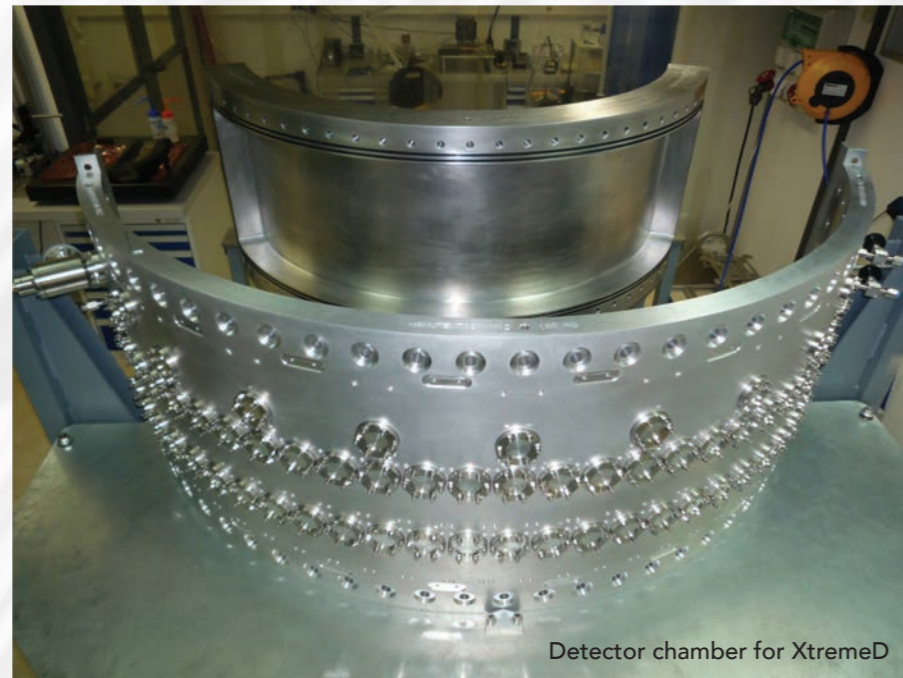

Detector chamber for XtremeD



5 out of 8 detector panels ready for PANTHER

ENDURANCE PHASE 2: H15

In the same way that the thermal guide H24 and its instruments are a key focus of Endurance-1, the cold guide H15 and its instruments are the cornerstone of Endurance-2. The guide which currently serves three instruments will have multiple branches serving up to six instruments, including two additional CRG instruments. This set of projects will be delivered by 2023.

PROJET	DESCRIPTION
H15	Guide renewal
D7+	Primary spectrometer
D11	Beam collimation
RAMSES	Primary spectrometer of SHARP (ex. IN6)
SAM	SANS instrument (CRG)
GAPS	TAS instrument (CRG)

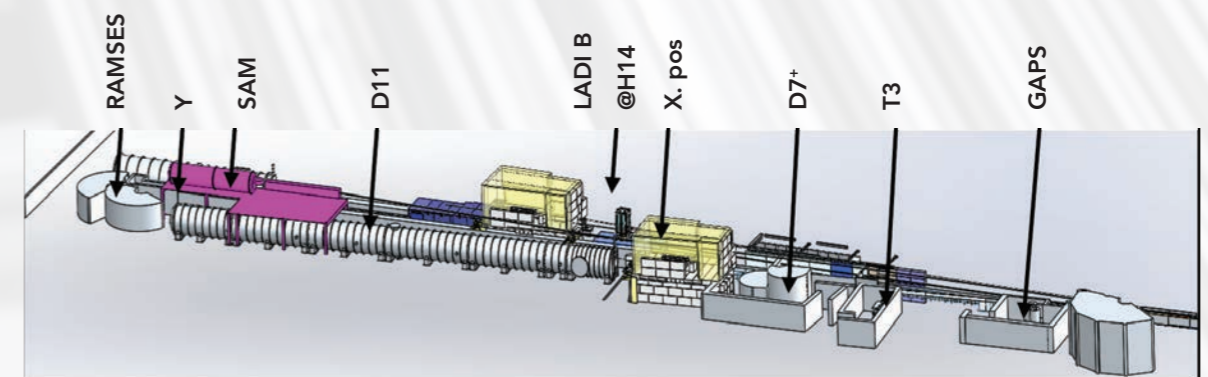

ENDURANCE PHASE 2: 2020-2023

The remaining projects in Endurance-2 will be executed in the period 2020-2023. They are a set of projects which generally are not mature enough to start before 2020. In any case, available resources for projects at ILL mean that there is a clear limit to the number of projects that can be conducted at any one time, as well as the amount of money that can be spent per year!

PROJET	DESCRIPTION
FIPPS	Gas filled magnet: mass spectrometer
D19	High count rate detector
RAINBOWS	Implementation on D17/FIGARO
WASP	Extra detectors & time-of-flight option
LAASI311	High-Q, Si311 analysers for IN16
MARMOT	Multiplexing analyser and detector for ThALES

Endurance performance gains: Many factors contribute to instrument performance like flux at the sample, detector coverage, signal-to-noise ratio and also reliability. The performance of the experimental programme at the ILL is influenced by a broader range of factors, including sample environment and data treatment, both of which are the subject of Endurance projects.

ENDURANCE PERFORMANCE GAINS

Many factors contribute to instrument performance like flux on sample, detector coverage, signal-to-noise ratio and also reliability.

Combining all these factors, the biggest gain is expected for PANTHER which should be 60 times better than IN4. A gain factor of 30 is expected for D7+ by matching the primary spectrometer to the secondary, which was upgraded in the Millenium programme and gave a 100-fold improvement at the time. The case of D7 illustrates that big gains are possible, for a given source, by ensuring that the instruments are optimally coupled to the source.

A gain factor of 30 is also expected with the implementation of RAINBOWS demonstrating that new measuring techniques can give very significant improvements.

An apparently modest gain factor of 2 will result from the creation of a second measuring station for LADI. For a low throughput technique, like protein crystallography, with limited capacity world-wide, this will be a highly significant improvement in capacity.

On average, it is estimated that each project will lead to a factor 10 improvement on each instrument.

Performance gains can affect capacity (e.g. flux) and capability. The public imaging instrument, the first of its kind at ILL, which will be created by the IM2020-NeXT project, will provide new capability at ILL. The very high, continuous flux at the ILL will provide world-leading capability in imaging.

The performance of the experimental programme at the ILL is influenced by a broader range of factors, including sample environment and data treatment, both of which are the subject of Endurance projects, NESSE and BASTILLE respectively.

Guide upgrades and focusing optics have, in the past, led to significant flux gains at the sample. H24 (thermal) and H15 (cold) guides and their instruments are the two, major guide projects in Endurance.

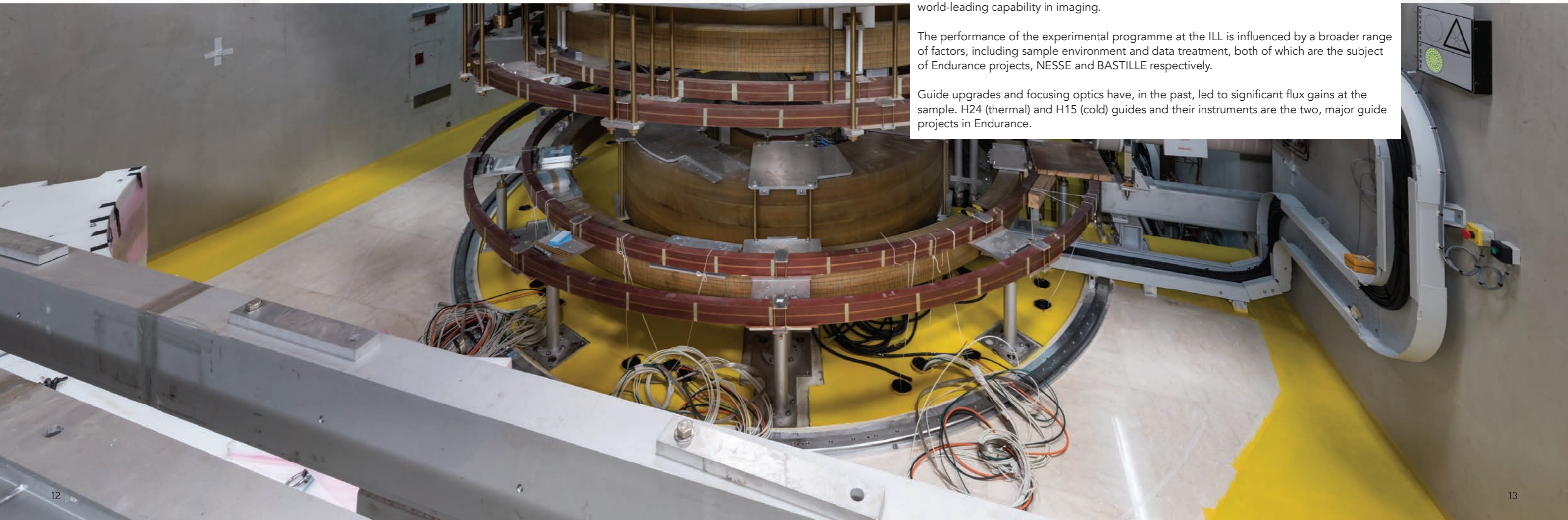



THE ILL ENDURANCE PROGRAMME



FIPPS - Fission Product Prompt γ -ray Spectrometer

C. Michelagnoli, Y.-H. Kim, F. Kandzia, E. Ruiz-Martinez, H. Faust, U. Köster, A. Blanc, A. Chebboubi, E. Froidefond, M. Jentschel, G. Kessedjian, P. Mutti, G. Simpson

- ✓ high flux ($10^8 \text{ ns}^{-1}\text{cm}^{-2}$) "pencil-like" thermal neutron beam
- ✓ HPGe clover detectors
- ✓ ancillary detectors
- ✓ digital electronics

High sensitivity nuclear studies after neutron-induced reactions:
 fundamental nuclear science and applications
(astrophysics, nuclear medicine, nuclear waste)

Examples:

Extract nuclear information useful for the understanding of the sites of heavy-elements nucleosynthesis

Quest for shape coexistence phenomena in atomic nuclei

symmetry around target position: assignment of spin and parity of nuclear states via angular correlations and linear polarization analysis

efficiency and granularity: reconstruction of nuclear level schemes through multiple γ -ray coincidences

measurement of nuclear level lifetimes via fast-timing techniques: determination of transition strengths

Physics possibilities:
 (n, γ) reactions on stable or radioactive targets: low and medium spin structure below neutron separation energy
 neutron-induced fission (with fission tag): structure of neutron-rich nuclei

Future perspectives (FIPPS phase II):
 fission fragment identification via a Gas-Filled-Magnet: structure of neutron-rich nuclei and fission studies

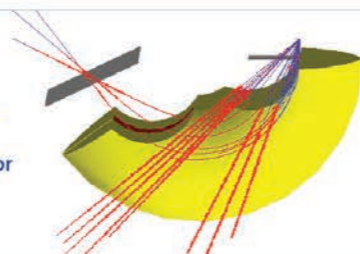

THE ILL ENDURANCE PROGRAMME



PANTHER – the new thermal TOF spectrometer @ ILL

The Panther Team
 S. Rols, B. Fåk, G. Manzin, B. Jarry, O. Meulien, B. Jarry and the SPECTROSCOPY group + ILL departments (SDN, BE, SON, SAE, SAME, SCI, DA ...)

Hybrid TOF (Large focusing monok. coupled to a fast rotating Fermi chopper)

High Flux ($\sim 5 \cdot 10^5 \text{ n/cm}^2/\text{s}$) - Medium resolution ($\sim 4\% \Delta E/E$) will replace IN4C (expected signal to noise ratio $\times 60$)

General thermal spectrometer
 Measure of Magnetic excitations, lattice dynamics, molecular spectroscopy
 Modern magnetism (new quantum states of matter, frustration, ...)
 Materials for energy (superconductors, multiferroics, thermoelectrics, ...)
 Complex molecular systems (nano scale organization, confined water, quantum confinement...)

Added capabilities: Single crystal and magnetism

2.5m radius cylindrical Flight Box equipped with $9 \times 32 \text{ m}$ high PSD ^3He tubes @ 10 bars

continuous coverage from 2° to $+135^\circ$ scattering angle range ($-15^\circ - 135^\circ$)

Polarisation Analysis (PASTIS3)
 10T « IN5 » magnet

Low Background

5 Choppers (composite material: carbon fibers and epoxy resin, 6 windows, 10 cm thickness)

Thick protection of the secondary spectrometer + Triple axis type Monochromator tourelle

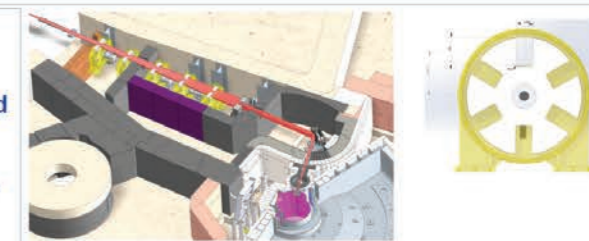

ENDURANCE POSTERS



THE ILL ENDURANCE PROGRAMME



THE ILL ENDURANCE PROGRAMME



SuperSUN – Superthermal Source of Ultracold Neutrons

Skyler Degenkolb, Oliver Zimmer,
 Eddy Lelièvre-Berna, Xavier Tonon, Eric Bourgeat-Lami, Michael Kreuz, Yves Gibert, Michel Thomas, ...

RAINBOWS - Refractive Analysis of the Incoming Neutron Beam Over the White Spectrum

R. Cubitt, J. Segura & W. Jark

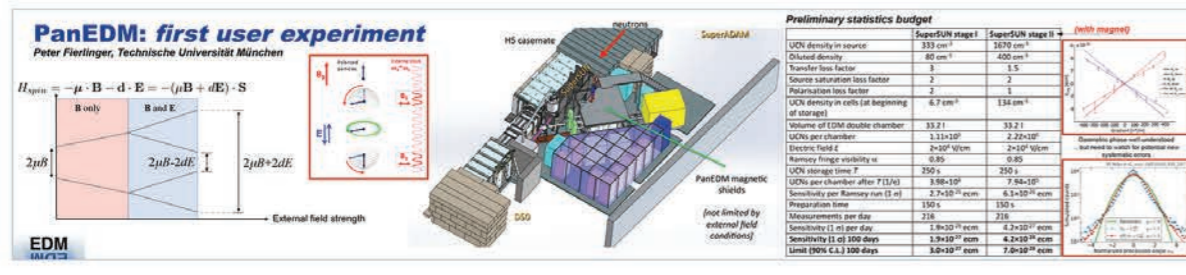
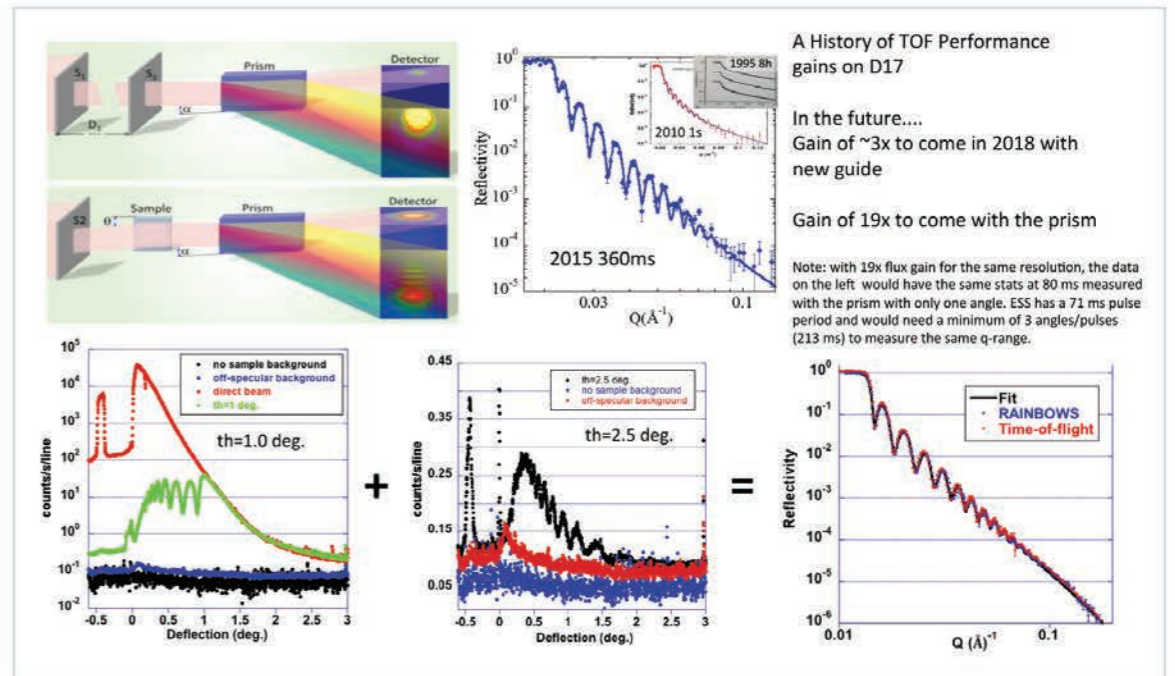
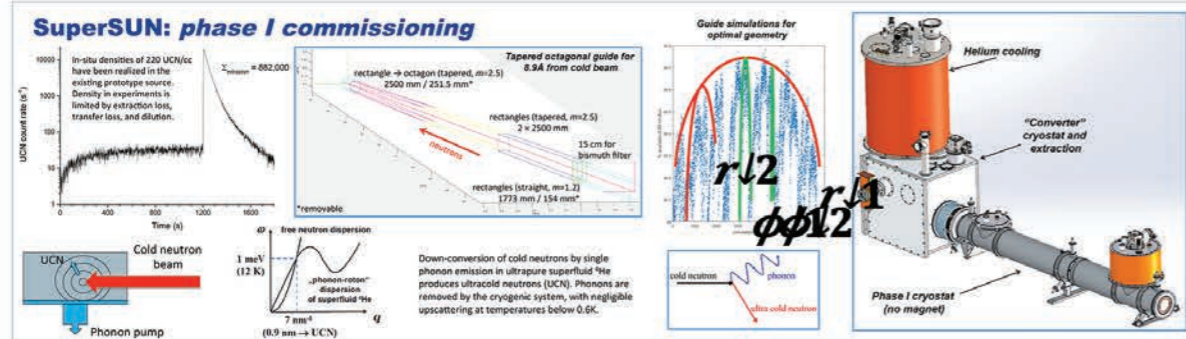
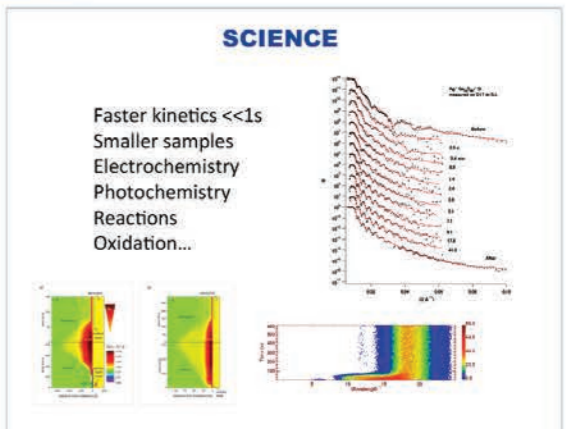
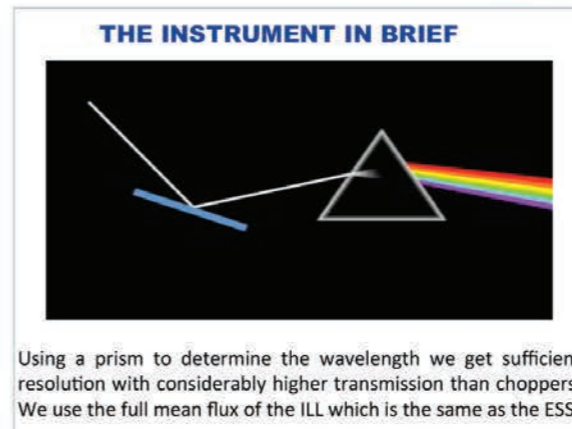
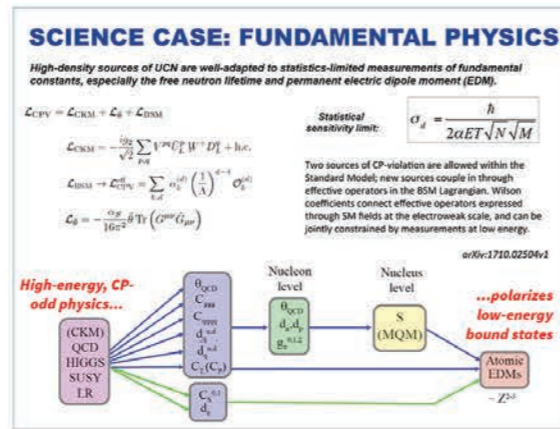
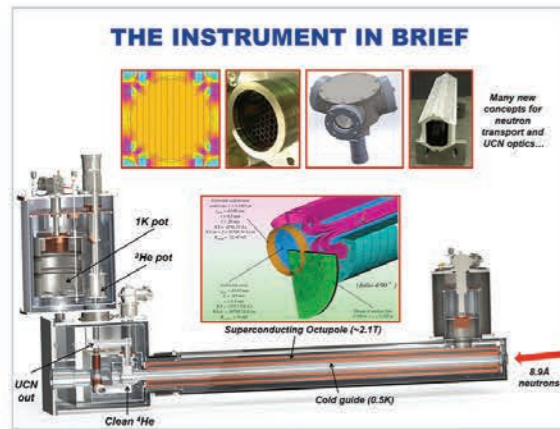

INSTITUT LAUE LANGEVIN - THE EUROPEAN NEUTRON SOURCE



INSTITUT LAUE LANGEVIN - THE EUROPEAN NEUTRON SOURCE

In-operando Si/Li battery: Seidhofer et al. ACS Nano. 10 7458-7466 (2016)
 Y. Sakaguchi et al. J. Appl. Phys. 120 055103 (2016)
 Macromolecules zhong et al. 46 4069 (2013)

Cubitt R., Segura J. & Jark W. J. Appl. Cryst. (2018) 51 257-263

ENDURANCE POSTERS



THE ILL ENDURANCE PROGRAMME



D10+ A new 4-circle, triple-axis diffractometer

B. Ouladiaz, N. Qureshi, J. Archer, J. Allibon, P. Decarpentrie and L. C. Chapon

THE INSTRUMENT IN BRIEF

D10 is a 4-circle diffractometer with optional energy analysis situated on the H24 neutron guide. It possesses a unique four circle dilution cryostat for temperatures down to 0.1K, and offers high reciprocal-space resolution and low intrinsic background, to medium real-space resolution.

CHARACTERISTICS

Parameter	Value
Wavelength	1.5 nm
Sample	10 x 10 mm ²
Detector	10 x 10 cm ²
Resolution	0.1°
Temperature range	0.1 K to 300 K
Pressure range	0.1 MPa to 10 MPa
Energy resolution	0.1%
Sample environment	4-circle dilution cryostat, pressure cell, etc.

SCIENCE

The various configurations of D10 associated with the different sample environments available, e.g. the unique 4-circle dilution cryostat, cryomagnets and pressure cells, allow the study of a wide range of materials like shape memory alloys, high-T_c superconductors, molecular magnets, magnetocalorics and functional materials such as multiferroics which are of great importance for future industrial applications.

INSTRUMENT AND NEUTRON GUIDE UPGRADE

New neutron guide with higher supermirror coating will increase the flux with moderate losses in resolution.

New dedicated end-of-guide position (at present IN3 position)

New and bigger detector with better spatial resolution and efficiency (in normal operation since March 2018)

New monochromator with motorised vertical curvature adapted to the guide cross section and neutron beam divergence.

New sample table free of magnetic materials allowing the use of 15 T magnetic fields. Completely rebuilt analyser stage

ESTIMATED GAINS

GUIDE SECTIONS

FLUX AT SAMPLE (1 CM²)

UP TO 5 TIMES MORE FLUX WITH MODERATE LOSSES IN RESOLUTION

RESOLUTION FUNCTION

UP TO 2 TIMES BETTER NEUTRON DETECTION EFFICIENCY

CONCLUSION

The instrument and neutron guide upgrade will increase the instrument's performance by an order of magnitude. This will enable the study of the magnetic properties of smaller single crystals (below 1 mm³) and thinner films (down to 100 Å with respect to the current state of art ~200 Å).



THE ILL ENDURANCE PROGRAMME



IN13+ - New perspectives for the high resolution thermal backscattering CRG spectrometer at ILL

F. Natali^{1,2}, J. Peters^{2,3}, L. Didier³
¹CNR-IOM Italy; ²Institut Laue-Langevin, Grenoble; ³LiPhy-UGA, Grenoble

THE INSTRUMENT IN BRIEF

Italian-French CRG operating since 1998 at ILL.

The high energy resolution (8 μeV, FWHM), together with the availability of high momentum transfer ($Q < 4.9 \text{ \AA}^{-1}$) makes the spectrometer particularly useful for the microscopic study of particle motions such as jump reorientation, rotational and translational diffusion, tunnelling, observed by incoherent neutron scattering.

SCIENCE

The time-length window of IN13 is of particular interest for the study of the internal dynamics of biological macromolecules in solution, powder or cell samples. Applications are found in biology, but also in medical science, chemistry, physics and cultural heritage.

The instrument will be repositioned on its own dedicated branch of the new H24 guide (m=2)

- New components: Helium box, Open m=2 guide, Obstrucators, Lead protections
- Primary spectrometer
- Secondary spectrometer
- m=2 guide → increase of neutron flux
- Graphite deflector
- H242
- H241
- Monochromator

End guide position: the insertion of a temperature gradient monochromator together with plastic mosaicity induced on the monochromator crystals will further optimize the neutron flux at the sample position.

GAIN IN FLU

Current situation:
 - Guide m=1 and old
 - Crystal mosaicity: 2-4 arcmin
 - No T gradient

Wanted situation:
 - Guide m=2
 - Crystal mosaicity: 10 arcmin
 - 14 C T gradient

Simulation studies: A.J.C. Dennison, F. Natali, E. Farhi, G. Manzin, P. Courtois, J. Peters - IN13 Neutron guide and primary spectrometer upgrade - Nuclear Instruments and Methods A: Accelerators (2018). Submitted



THE ILL ENDURANCE PROGRAMME



XtremeD - A new diffractometer for extreme conditions of pressure and magnetic field

J.A. Rodriguez-Velamazán, G. Manzin and all the XtremeD team

THE INSTRUMENT IN BRIEF

- A powder diffractometer with single-crystal capabilities
 - High pressures (\rightarrow 30-50 Gpa)
 - High magnetic field (up to 17 Tesla / pulsed field option)
- Requires high neutron flux and low background \rightarrow guide hall position, new branch on thermal guide H24
- Flux \sim D20, with higher detector coverage. Dedicated.
- Special sample environment \rightarrow in a second phase
- Joint project between ILL and Spanish CSIC. CRG instrument.

SCIENCE

Crystallography, geosciences, Magnetism

XtremeD

PNAS: Neutron diffraction observations of interstitial protons in dense ice
 25-50 Gpa, RT

Giant spin-driven ferroelectric polarization in TbMnO₃ under high pressure
 EAFM (P//H) \sim 5 GPa

Pressure-induced change in the magnetic ordering of TbNiCl₃
 GPa

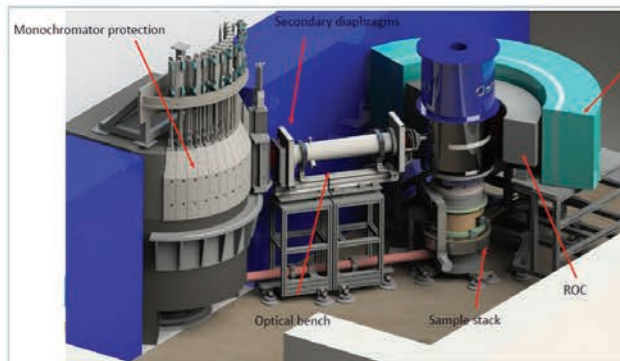

DETECTOR

- New 2D curved detector: high resolution, high counting rate, large solid-angle
- ³He-MWPC (multi-wire proportional chamber)
- 130 deg. horizontal, \pm 15 deg. vertical, 76 cm radius
- 9 modules, 14.4 deg. each.
- > 200 kHz/module

TOURELLE, OPTICAL BENCH, DIAPHRAGMS, AMAGNETIC SAMPLE STAGE, ROC...

MONOCHROMATORS

Si double-focusing bent crystals monochromator

HOPG double-focusing crystal array monochromator

MILESTONES

- May, 2016: Launch of execution phase
- 2016-2018: Calls for tenders and fabrication of different components
- End 2018: Detector delivery
- End 2018: Start of component commissioning
- End 2019-2020 (?): new H24 guide installation
- Mid 2020: Instrument assembly and installation. Commissioning



INSTITUT LAUE LANGEVIN - THE EUROPEAN NEUTRON SOURCE



THE ILL ENDURANCE PROGRAMME



IN5 - H16 optimised replacement guide

J. Ollivier, B. Giroud, M. Kreuz, M.M. Koza, E. Farhi, J. Beaucour, Ch. Dewhurst

THE INSTRUMENT IN BRIEF

IN5 is a high precision direct geometry Time-of-flight (ToF) spectrometer. It is used to study low-energy transfer processes as a function of momentum transfer.

SCIENCE

Quasi-Elastic in amorphous, biologic and liquid systems

Phonons in classical and quantum crystals

Excitations in molecular nanomagnets

Classical and quantum magnetism

Excitations in quantum liquids

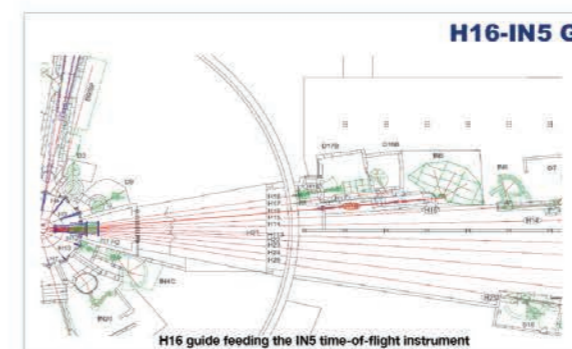

Goals:

- Extend wavelength range: 2 – 15Å \rightarrow 1.5 – 15Å
- Increase flux at any wavelength
- Extend configuration range (Q-E) space
- Improve signal/noise

Means:

- Recent supermirror guides with higher M-index
- Optimised guide geometry for better transport
- Improved neutron shielding around the guide

Optimal geometry

Gain at sample

Gains are $>$ 2 below 7 Å, = 3 at 4 Å, 5 at 2 Å.

Divergences

Gain vs. sample height

Divergences vs. guide end height



INSTITUT LAUE LANGEVIN - THE EUROPEAN NEUTRON SOURCE



THE ILL ENDURANCE PROGRAMME



D3 Liquids - "Direct" measurement of the coherent cross section in liquids and glasses

Anne Stunault, Sebastien Vial, Gabriel Cuello, David Jullien, Bruno Guérard, Jean-Claude Buffet

THE INSTRUMENT IN BRIEF

The polarised hot neutron diffractometer D3 is a unique instrument to determine the coherent structure factors of disordered materials with a high hydrogen contents, thanks to 2 main features:

- 1/ Polarised neutrons:
 - $I_{spin-incoherent}(Q): 1/3 \text{ non-spin-flip}$
 - $2/3 \text{ spin-flip}$
 - $I_{coherent}(Q): \text{non-spin-flip}$
 - $I_{long-range-incoherent}(Q): \text{non-spin-flip}$

2/ Hot neutrons: structural information need data at high Q (Fourier transform), hence the need for short wavelengths.

Such studies are routinely achieved on D3 (initially a single crystal diffractometer), scanning a single detector (2-3 days/sample). Within the Endurance project, D3 will be equipped with a small 1D multidetector (2-3 samples/day).

SCIENCE

The studied disordered materials include liquids, glasses, quasi-crystals and nano-sized systems, from fundamental research to health and environmental sciences, or applied research

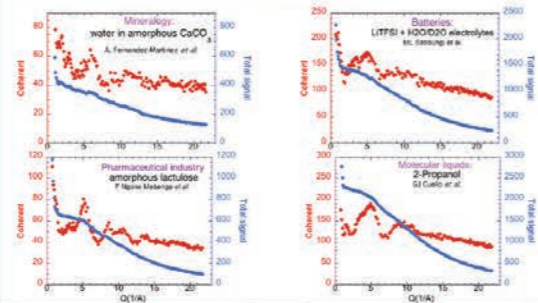

TECHNICAL DETAILS

The instrument upstream from the sample has already been commissioned. The project includes the development of a new large parallelepipedic ³He spin filter and a new multiwire linear detector, with 4 rows of tubes for high efficiency at short wavelengths

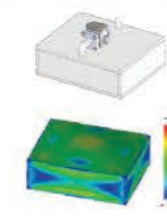
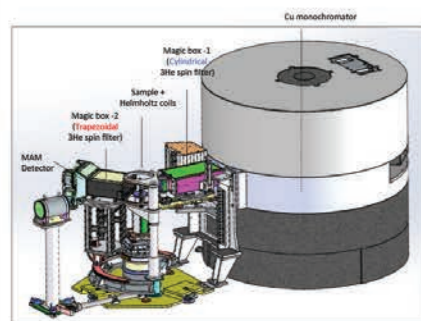

Large ³He spin filter
160 x 200 x 65 mm³



Multiwire linear detector with 4 rows of tubes, spanning 20°



Double-walled vanadium sample container. Accommodate 3-containers

USE and PERFORMANCES

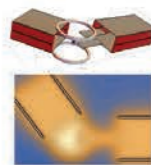

Polarization loss along the beam path < 1% (currently ~ 5%)
 Flux x 10 : 2-3 samples / day (currently 2-3 days / sample)

Use in conjunction with:
 D7: low Q (up to 2.5 Å⁻¹)
 D4: deuterated samples

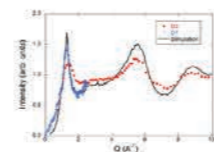

Amorphous pharmaceutical lactulose (thesis, F. Ngono Mbengwa)



THE ILL ENDURANCE PROGRAMME



IN20 Upgrade

Mechthild Enderle, Tobias Weber, Philippe Chevalier, Frederic Thomas

THE UPGRADE IN BRIEF

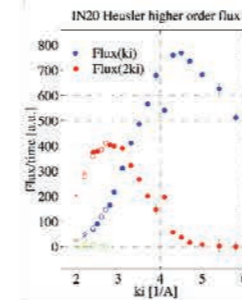

1. translatable higher order filter (velocity selector)
2. double-focusing PG monochromator
3. double-focusing PG analyser
4. wide-diameter low-background thermal multi-analyser (for PASTIS, Cryomagnets)

SCIENCE

Superconductivity, high-Tc/pnictides
 orbital/charge transfer phenomena
 exotic excitations/quantum magnets
 strong spin-orbit coupling phenomena

multiferroics
 polarised overview

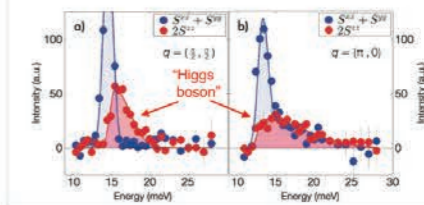

Dalla Piazza et al., Nat. Phys. 2015
 Jain et al., Nat. Phys. 2017

Present IN20 strengths

- small samples
- weak signals
- large horizontal and vertical cryomagnets
- zero-field polarisation analysis

Present IN20 limits

- weak signals
- higher order leads to spurious and background
- only 2 choices of kf
- polarised overview difficult

IN20 Upgrade

- present possibilities untouched
- progress in modular form — no down time

- clean flux
- signal gain (PG monochromator/analyser)
- gain in versatility (choice of kf)
- gain in resolution via PG(004)
- overview with cryomagnets or PASTIS: signal gain and background suppression

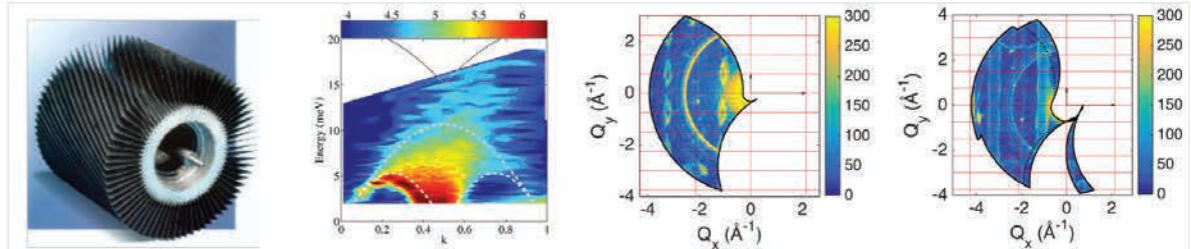
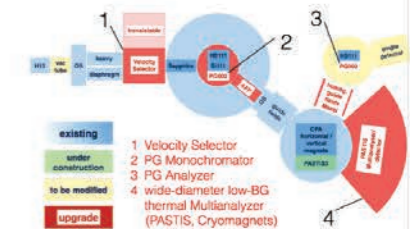



THE ILL ENDURANCE PROGRAMME



RAMSES# - a multi-purpose time-of-flight spectrometer

Michael Marek Koza, Jean-Marc Zanotti, Benjamin Giroud

RAMSES# IN BRIEF

RAMSES# is a time-of-flight spectrometer projected as a successor of the cold-neutron IN6 instrument. Its functioning is based on a multiple monochromator unit and a Fermi-chopper for monochromatisation, beam pulsing and thus analysis of the scattered neutron spectrum.

Design targets :

- Incident wavelength range 2 – 16 Å
- Scattering angle coverage -5° - 135°
- Position-sensitive ³He detector unit
- Highest flux in 10x10 mm² beam spot
- Beam compression by multichannel guide
- Freely accessible sample box

SCIENCE COVERAGE

Extended dynamic and spatial range coverage, higher flux with smaller beam size and optional beam compression aim at an optimum service of contemporary science.

- C4: magnetic excitations
- C6: Structure and dynamics of liquids and glasses
- C7: Spectroscopy in solid state physics and chemistry
- C8: Structure and dynamics of biological systems
- C9: Structure and dynamics of soft-condensed matter

SPECIFIC SCIENCE TARGETS

- Local and long range Diffusion in membrane and energy materials: Zeolites, Perovskites, Clathrates, PCCP, Proton dynamics in perovskite fuel cell membrane material.
- Dynamics in composite materials, e.g. hydrate clathrates for: Energy resource - CH₄ recovery, Geo-engineering - CO₂ sequestration, Industrial risks - pipeline clogging, Methane diffusion in hydrate clathrate at metastable condition, Quantum states of H₂ in a hydrate.
- Localized spin and correlated magnetic excitations: Quantum magnets, Magnons, High-Tc superconductivity, Magnon dispersion of BNFS.
- Phonons, vibrations and magnetic excitations in thermoelectric and multiferroic compounds: Phonon renormalization for efficient thermoelectrics.
- Matter at extreme conditions, small samples, and in-situ simultaneous and pump-probe experiments: Laser, Dielectric, Low-field NMR.

RAMSES# a path to supremacy

Component / Component	Characteristics
Mono - Sample	2.0 m
Fermi chopper - Sample	0.4 m
Sample - Detector	2.8 m
PSD angle	-5° - 135°
PSD height/beam	200.0 / 2.6 cm
Detector box	Vacuum
Sample box	Application dependent

- September 2017 - January 2018: Call for tender and designation of the contractor (SDMS) for design study and construction of a new PSD equipped vacuum detector box.
- November 2018 - April 2019: Installation of a marble ground at IN6 for the new detector box.
- November 2019 - August 2020 (ILL long shutdown): Decommissioning of IN6 and installation of the new secondary spectrometer.
- September 2020 - August 31 2021: Normal operation with the new secondary spectrometer at IN6 position (operated by LLB personnel 2 Scientists, 1 Technician as CRG-A instrument)
- Beyond September 1st 2022: H15 guide upgrade, installation of the new RAMSES# primary spectrometer at an end position of H15, and consolidation with the secondary spectrometer.



INSTITUT LAUE LANGEVIN - THE EUROPEAN NEUTRON SOURCE



THE ILL ENDURANCE PROGRAMME



D7+ - Permanently-polarized diffuse scattering spectrometer

Lucile Mangin-Thro, Benjamin Giroud, Charles Dewhurst, Goran Nilsen, Katherine Brown, Wayne Clancy and Andrew Wildes

THE INSTRUMENT IN BRIEF

- Dedicated guide with large divergence
- In-guide polarization with a deflector
- Double-focusing monochromator, 3 Å ≤ λ ≤ 6 Å
- Fermi chopper for spectroscopy
- Evacuated flight path
- Supermirror analysers with coverage of 0.41 steradians
- Position-sensitive detectors

SCIENCE

- Magnetic short-ranged order (frustrated magnets, spin glasses, paramagnetism)
- Separation of magnetic / nuclear scattering (superconductors, weak magnetism, disordered compounds)
- Separation of coherent / incoherent scattering (hydrogen-containing compounds)
- Spectrometry (magnetic dynamics, quasielastic scattering)

D7+ schematic:

- Flux ≥ 10× current D7
- Resolution ≈ current D7



INSTITUT LAUE LANGEVIN - THE EUROPEAN NEUTRON SOURCE



THE ILL ENDURANCE PROGRAMME



Marmot – Multiplexed Array for Mapping on ThALES

M. Boehm¹, P. Steffens¹, M. Valeska^{1,2}, E. Villard¹, K. Lefmann³, P. Javorsky²
¹Institut Laue-Langevin, 38042 Grenoble, France
²Faculty of Mathematics and Physics, Charles University, 121 16 Praha 2, Czech Republic
³Niels Bohr Institute, University of Copenhagen, 21000 København, Denmark



THE ILL ENDURANCE PROGRAMME



LADI-B – Extending the capacity and capability for neutron macromolecular crystallography

M.P. Blakeley, N. Coquelle, W. Clancy, R. Cubitt, C.D. Dewhurst, B. Giroud, G. Fragneto

THE INSTRUMENT IN BRIEF

MARMOT is a multiplexed analyzer-detector stage for the cold three axis-spectrometer ThALES covering a scattering angle of maximum 100 degrees and up to maximum 7 separated energy channels. As its predecessor FlatCone it is foreseen as an interchangeable analyzer-detector unit replacing the classical secondary spectrometer of ThALES for applications necessitating a coverage of about 1 to 2 Brillouin zones with data collection in several energy channels in parallel. The data acquisition rate should increase by about a factor 50 with respect to the standard unit.

SCIENCE

MARMOT is foreseen as an efficient method for analysing the dynamics of correlated electronic systems and exotic spin quantum systems with broad features in the scattering function $S(Q, \omega)$ such as non-conventional superconductors, strongly frustrated, low dimensional or disordered systems. ThALES with MARMOT combines the momentum (Q) and energy (ω) range, the typical cold TAS energy resolution and the unrivalled cold neutron flux of ThALES with the routine operation of complex sample environment (such as high fields, very low temperature devices and pressure cells).

The example below shows the magnetic response $S(Q, \omega)$ in the spin $\frac{1}{2}$ compound YbMgGaO_4 at five different constant energy transfers $E = \hbar\omega = 0.3, 0.6, 1.0, 1.2$ and 1.5 meV. YbMgGaO_4 is handled as promising candidate for a 2D spin liquid system (Y. Shen et al., Nature 540, 559 (2016)). The measurements have been done on FlatCone with about 12 hours / energy transfer. With MARMOT all five transfers can be measured at once.

MAPPING ON TAS: 15 years of science and continuous developments

At ILL the FlatCone analyzer system is routinely used on the three TAS (IN3, IN20 and ThALES) since 2005 (M. Kempa et al., Physica B 385–386 (2006) 1080–1082). FlatCone has 31 angular channels covering 75° of the scattering plane. One energy channel is available per setup, either $E=18.6$ meV for IN3 and IN20 or $E=4.1$ meV for Thales. Its analyzers consist of bent Si111 crystals scattering the neutrons from the sample into horizontally aligned detector tubes, about 50 cm above the scattering plane.

A characteristic of FlatCone is the tilting option for accessing out-of-plane momentum transfers, parallel to the zero degree scattering plane. FlatCone is mainly used for mapping diffuse scattering over large parts of the Brillouin zones, typically encountered in disordered materials or quantum magnetic systems.

Mapping analyzer-detector systems with single crystal analyzers have been constantly developed and improved on various TAS at different neutron centers. Several energy channels aligned in one angular channel, similar to the future MARMOT, have been implemented at: MultiMax at FLEX, WIZB: 5 energy channels, 31 angular channels, total angular coverage 78° (F. Groll et al., Scientific Reports 7 (2017), 13637). Bamboo at Panda, FRM-II: 5 energy channels, 25 angular channels, total angular coverage 75° (J. A. Lim et al., J. Phys.: Conf. Ser. 592 (2015) 012145). For CAMBA at RITA-A, PSX, analyzers are arranged on arcs covering 60° of the scattering plane for 8 different final energies. Neutrons are scattered into a 2D PSD detector (F. Groll et al., Rev. Sci. Instr. 87 (2016) 035109). For the future BIFROST spectrometer at ESS, Lund, a multiplexed secondary spectrometer based on single-crystal PG002 analyzers is equally foreseen: [https://europeanscienceinfrastructure.eu/article/bifrost-prismatic-approach-neutron-spectroscopy].

PROJECT OVERVIEW

Feasibility phase until spring 2019

MARMOT is presently in the feasibility phase of the project. Various neutron tests will be performed on a single angular testing channel comprising 5 analyzer crystals (see picture to the left) with the following aims:

- Comparison PG002 and Si111 as analyzer material in terms of signal to noise.
- Stacking geometries for Si111 analyzer crystals.
- Detector geometry.

Cost estimates and timeline

June 2019	End of feasibility phase: Design, detailed cost-estimates.
T ₀	Kick-off.
T ₀ + 6 months	Detailed engineering studies, calls for tender, procurement of off-the-shelf components, start manufacturing.
T ₀ + 18 months	End of construction phase, commissioning time (equivalent of 1 reactor cycle).
T ₀ + 24 months	Entering into user program.

Total: 1.1 M€
The cost estimate is based on 30 angular channels with 5 Si111 crystals each and individual detectors for every angular and energy channel.

THE INSTRUMENT

- LADI-B will extend the range of systems to those with larger unit cells ($>100\text{\AA}$)
- Combines quasi-Laue data collection with a large cylindrical detector
- Utilizes a narrower neutron bandwidth ($\delta\lambda/\lambda=15\%$) compared to LADI ($\delta\lambda/\lambda=30\%$)
- Data collection will be possible at room- or low-temperatures (down to 80K)

THE SCIENCE

- H-atoms & protons (H⁺) play key roles in numerous biological systems and processes
- Knowledge of their positions is essential e.g. in elucidation of enzyme mechanisms and for improving drug-design
- Neutron crystallography is the only approach to locate mobile H-atoms/protons and without radiation damage issues

HIV drug design studies

An intense HIV virus particle during the process of maturation. HIV protease (A) cleaves proteins required for infection to mature and become infectious and also is a target in HIV therapy.

Neutron diffraction allows direct location of H-atoms and H⁺ positions, revealing the H-bonding interactions in the active site.

But, details of H-bonding interactions are not directly resolved with X-ray.

AN EXPANDING FIELD

- Improvements to LADI at HI43, along with new instruments online (MLZ, ORNL etc) led to an expanding field with **>81% (115/142) structures determined since 2009**
- Number of proposals, days requested and overload rate all increasing for LADI

Year	Proposals	Days requested	Overload
11/12	23	288	2.3
13/14	27	357	2.6
15/16	50	713	2.9

HIGH-IMPACT

- Results are often medically relevant and of high-significance
- Reflected by publications in high-impact journals e.g. Science, Nature Commun, Angewandte Chem.
- Average impact-factor per publication = 6.8

Vitamin B6-dependent enzymes

Before and after synthesis of the 1st step in enzymic pathway of AAT.

Cryo-trapping heme enzyme intermediates

Discovered new nature of the intermediate Compound I and Compound II in heme peroxidase via data collection at 100K.

LADI-B SITING

- LADI-B will be sited in front of LADI at the end-position of cold neutron guide HI41
- Planned to be in place for **commissioning by the last cycle of 2019**

EXTENDING THE LIMITS

- LADI-B will allow us to do extend the capacity and capability for neutron MX
- Reduced bandwidth of LADI-B (cf LADI) will (i) improve data completeness for large cells (i.e. 80 - 100Å on edge) and (ii) allow us to extend the limits to >100 Å on edge

DNA polymerases

DNA polymerases play a central role in cell division, duplicating DNA and passing it to new cells.

Unit-cell = 93, 106, 150 Å (P2,2,2)

Acetylcholinesterase

Acetylcholinesterases catalyze the breakdown of the neurotransmitter acetylcholine. They are the target of inhibition by nerve agents and pesticides.

Unit-cell = 126, 126, 134 Å (P1,1,2)



THE ILL ENDURANCE PROGRAMME



IM2020 - NeXT - The Neutron and X-ray Tomograph of ILL

A. Tengattini, N. Lenoir, E. Andò, R. Cubitt, N. Kardjilov, C. Dewhurst, B. Giroud, D. Atkins, J. Beaucour, G. Fragneto, M. Johnson, G. Viggiani,

THE INSTRUMENT IN BRIEF

NeXT-Grenoble will be ILL's first public Neutron and X-ray Tomograph, born from a collaboration with the Université Grenoble Alpes (UGA) and Helmholtz-Zentrum Berlin (HZB)

It will be a world-leading imaging instrument, taking full advantage of the unique flux of the ILL (of particular importance in tomography), and employing state-of-the-art technical solutions to offer a broad portfolio of options and contrast mechanisms.

SCIENCE

Tomography measures a 3D attenuation field of a scanned object by acquiring a number of projections at different angles followed by a reconstruction. It is at the heart of a veritable revolution in a growing number of fields.

It enables quantitative geometrical measurements combined with complex sample environments. Given its no-destructive nature, processes can be studied by repeating 3D measurements while a sample evolves.

These time series data provide another key route for quantitative measurements of sample evolution: the most powerful technique being Digital Volume Correlation which allows material displacements far below the pixel size to be measured.

THE TECHNIQUES OF NeXT

- Complementary (x+n) studies at high resolution (<5µm) and high speed (<1s)
- Advanced processing
- Grating Interferometry
- Energy Selective Imaging
- Polarised Imaging

(FEW) EXAMPLES OF APPLICATION

- Tests in extreme conditions:** The insensitivity to metals of neutrons allows in-situ test at high temperatures (a), pressures (b), and load (c).
- Tracking Fluids:** Neutron imaging is ideal to track water and hydrocarbons in complex porous media (a,b and c).
- X-ray or Neutrons? Both!** X-ray and neutrons are highly complementary and some problems can only be tackled combining both!
- ...and much more!** The applications are countless from historical artefacts (a), to fuel cells (b) to biology (c).



INSTITUT LAUE LANGEVIN - THE EUROPEAN NEUTRON SOURCE



THE ILL ENDURANCE PROGRAMME



³He Detector development in Endurance

Jean-Claude Buffet, Jean-Francois Clergeau, Sylvain Cuccaro, Bruno Guérard, Julien Marchal, Jérôme Pentenero

Several projects in the Endurance program rely on new detectors to enable new science or to improve performance on existing instruments

Endurance projects with in-house development of ³He detectors

- XtremeD: Large area 2D curved MWPC for very high counting rate
- PANTHER: Large area MultiTube
- D3: Monoblock Aluminium MultiTube (MAM) for improved sensitive area and high detection efficiency
- D20: 1D curved MWPC to replace the old MSGC detector for improved reliability
- D16: Large area 2D curved MWPC to replace the old MWPC for larger sensitivity area, and improved reliability
- D19: XtremeD-type MWPC to replace the old MWPC for improved counting rate and improved reliability

Other detector projects in Endurance

- D10+: New MultiWire Proportional Chamber (MWPC) to replace the old MSGC for improved counting rate (already operational)
- Rainbows: The ILL Multiblade ¹⁰B-film detector technology, currently developed at ESS, is considered
- Thales, WASP, and D7+: standard ³He PSDs
- D22: 100 ³He PSDs will equip a high angle detector bank
- D11: The old 2D MWPC will be replaced by a fast detector covering a sensitive area 2 times larger made of 272 ³He D22-type PSDs

For D11 and D22, one challenge is to design the mechanics for mounting the PSDs with high precision and minimum dead zone

Development of ³He detectors

trench-MWPCs for XtremeD, D16 and D19

2-dim position sensitive

A 2D curved detector with an horizontal aperture of 130°, is under fabrication for XtremeD. This detector will be duplicated for D19 in a further step. An other detector is under study for D16 with an horizontal aperture of 85°. The radius of curvature will be 115 cm for D16 and 85 cm for XtremeD and D19. These 3 detectors are based on the trench technique which enhance the counting rate capability of MWPCs.

The XtremeD vessel after its arrival at the ILL (left), and view of the trench cathode (right) in the prototype

Counting rate curve measured with the XtremeD prototype

trench-MWPC for D20

1-dim position sensitive

The MSGC detector of D20 is operational without interruption since 2000. Due to the complexity and duration of an intervention in case of failure, and considering the age of the detector, a new one, based on the trench-MWPC technique will be fabricated.

Views of the D20 trench-MWPC under study. The vessel of the old D20 prototype will be equipped with a trench-MWPC sector and tested with a neutron source to validate the design

MAM for D3

1-dim position sensitive

Technical view of the Aluminium Monoblock MultiTube under fabrication. The pressure vessel will be able to contain 15 bar of gas. The detector has been optimized to provide maximum detection efficiency and minimum background noise. The expected efficiency is > 50% at 0.5 Å

All mechanical parts will be fabricated in the mechanical workshop of the ILL

In the D3 detector, one angular channel corresponds to 4 tubes connected together. Two electronics cards, 32 channels each, will be used to read out the 64 channels

MultiTube for PANTHER

2-dim position sensitive

The instrument will be equipped with 9 MultiTube modules. Each of them is made of 32 stainless steel tubes welded on both sides on s.s. flanges. Tubes have a sensitive length of 2 m, and a diameter of 2.2 cm.

One of the PANTHER modules in the ILL3 detector lab. Ceramics insulators are mounted on both ends of the tubes to support the anode wires. These wires are crossed with small copper tubes, and connected to the readout electronics via PCBs and 32-pins feedthrough. Test images measured with an AmBe neutron source allow to verify that the detectors are operational.

The fabrication of the 9 modules is already well advanced. Each module will be tested with 16 bar of gas for pressure vessel certification.



INSTITUT LAUE LANGEVIN - THE EUROPEAN NEUTRON SOURCE

